

GigaX Series

Layer 3 Managed Switch

User Guide

Exxxx

First Edition V1

March 2005

Copyright © 2005 ASUSTeK COMPUTER INC. All Rights Reserved.

No part of this manual, including the products and software described in it, may be reproduced, transmitted, transcribed, stored in a retrieval system, or translated into any language in any form or by any means, except documentation kept by the purchaser for backup purposes, without the express written permission of ASUSTeK COMPUTER INC. (ASUS).

Product warranty or service will not be extended if: (1) the product is repaired, modified or altered, unless such repair, modification or alteration is authorized in writing by ASUS; or (2) the serial number of the product is defaced or missing.

ASUS provides this manual "as is" without warranty of any kind, either express or implied, including but not limited to the implied warranties or conditions of merchantability or fitness for a particular purpose. In no event shall ASUS, its directors, officers, employees, or agents be liable for any indirect, special, incidental, or consequential damages (including damages for loss of profits, loss of business, loss of use or data, interruption of business and the like), even if ASUS has been advised of the possibility of such damages arising from any defect or error in this manual or product.

Specifications and information contained in this manual are furnished for informational use only, and are subject to change at any time without notice, and should not be construed as a commitment by ASUS. ASUS assumes no responsibility or liability for any errors or inaccuracies that may appear in this manual, including the products and software described in it.

Products and corporate names appearing in this manual may or may not be registered trademarks or copyrights of their respective companies, and are used only for identification or explanation and to the owners' benefit, without intent to infringe.

Federal Communications Commission Statement

This device complies with Part 15 of the FCC Rules. Operation is subject to the following two conditions:

- This device may not cause harmful interference, and
- This device must accept any interference received including interference that may cause undesired operation.

This equipment has been tested and found to comply with the limits for a Class B digital device, pursuant to Part 15 of the FCC Rules. These limits are designed to provide reasonable protection against harmful interference in a residential installation. This equipment generates, uses and can radiate radio frequency energy and, if not installed and used in accordance with manufacturer's instructions, may cause harmful interference to radio communications. However, there is no guarantee that interference will not occur in a particular installation. If this equipment does cause harmful interference to radio or television reception, which can be determined by turning the equipment off and on, the user is encouraged to try to correct the interference by one or more of the following measures:

- Reorient or relocate the receiving antenna.
- Increase the separation between the equipment and receiver.
- Connect the equipment to an outlet on a circuit different from that to which the receiver is connected.
- Consult the dealer or an experienced radio/TV technician for help.

WARNING! The use of shielded cables for connection of the monitor to the graphics card is required to assure compliance with FCC regulations. Changes or modifications to this unit not expressly approved by the party responsible for compliance could void the user's authority to operate this equipment.

Canadian Department of Communications Statement

This digital apparatus does not exceed the Class B limits for radio noise emissions from digital apparatus set out in the Radio Interference Regulations of the Canadian Department of Communications.

This class B digital apparatus complies with Canadian ICES-003.

ASUS contact information

ASUSTeK COMPUTER INC. (Asia-Pacific)

Address: 150 Li-Te Road, Peitou, Taipei, Taiwan 112
General Tel: +886-2-2894-3447
General Fax: +886-2-2894-7798
Web Site: www.asus.com.tw

Technical Support

MB/Others (Tel): +886-2-2890-7121 (English)
Notebook (Tel): +886-2-2890-7122 (English)
Desktop/Server (Tel): +886-2-2890-7123 (English)
Networking (Tel): +886-2-2890-7902 (English)
Support Fax: +886-2-2890-7698

ASUS COMPUTER INTERNATIONAL (America)

Address: 44370 Nobel Drive, Fremont, CA 94538, USA
General Fax: +1-502-933-8713
General Email: tmd1@asus.com
Web Site: usa.asus.com

Technical Support

Support Fax: +1-502-933-8713
General Support: +1-502-995-0883
Notebook Support: +1-510-739-3777 x5110
Support Email: tsd@asus.com

ASUS COMPUTER GmbH (Germany and Austria)

Address: Harkort Str. 25, D-40880 Ratingen, BRD, Germany
General Fax: +49-2102-9599-31
General Email: sales@asuscom.de (for marketing requests only)

Technical Support

Support Hotlines: (Components) +49-2102-95990
(Notebook PC) +49-2102-959910
Support Fax: +49-2102-959911
Support Email: www.asuscom.de/de/support (for online support)
Web Site: www.asuscom.de

Table of Contents

1	Introduction.....	12
1.1	L3 managed features	12
1.2	Conventions used in this document.....	14
1.2.1	Notations.....	14
1.2.2	Typography.....	14
1.2.3	Symbols	14
2	Getting to know the GigaX	15
2.1	Package contents.....	15
2.2	Front Panel.....	16
2.3	Rear Panel	18
2.4	Technical specifications	18
3	Quick start guide	19
3.1	Part 1 — Installing the hardware.....	19
3.1.1	Installing the switch on a flat surface.....	19
3.1.2	Mounting the switch on a rack	19
3.2	Part 2 — Setting up the switch.....	20
3.2.1	Connect the console port.....	20
3.2.2	Connect to the computers or a LAN	20
3.2.3	Attach the RPS module	20
3.2.4	Attach the power adapter.....	20
3.3	Part 3 — Basic switch setting for management	22
3.3.1	Setting up through the console port.....	22
3.3.2	Setting up through the Web interface	25
4	Management with the Web Interface	27
4.1	Log into Web user interface	27
4.2	Functional layout.....	28
4.2.1	Menu navigation tips.....	31

4.2.2	Commonly used buttons and icons.....	31
4.3	System Pages	32
4.3.1	Management	32
4.3.2	IP Setup	33
4.3.3	Administration	34
4.3.4	Reboot.....	34
4.3.5	Firmware Upgrade	35
4.4	Physical Interface	36
4.5	Route.....	38
4.5.1	Interfaces	38
4.5.2	Static Route	40
4.5.3	RIP	41
4.6	Bridge.....	42
4.6.1	Spanning Tree/Rapid Spanning Tree	43
4.6.2	Link Aggregation	44
4.6.3	Mirroring.....	46
4.6.4	Static Multicast.....	48
4.6.5	IGMP Snooping.....	48
4.6.6	Traffic Control	49
4.6.7	Dynamic Addresses	50
4.6.8	Static Addresses	52
4.6.9	Tagged VLAN	53
4.6.10	Default Port VLAN and CoS.....	55
4.6.11	CoS Queue Mapping	56
4.6.12	DHCP Snooping.....	56
4.7	SNMP.....	58
4.7.1	Community Table.....	58
4.7.2	Host Table.....	59
4.7.3	Trap Setting	60
4.7.4	VACM Group.....	60
4.7.5	VACM View	61
4.7.6	USM User.....	63
4.8	Filters.....	65
4.8.1	Filter Set.....	65

4.8.2	Filter Attach.....	68
4.9	Security	70
4.9.1	Port Access Control	70
4.9.2	Dial-In User	72
4.9.3	RADIUS	73
4.10	Statistics Chart	74
4.10.1	Traffic Comparison	74
4.10.2	Error Group	75
4.10.3	Historical Status	75
4.11	Save Configuration.....	77
5	Console Interface	78
5.1	Power On Self Test.....	79
5.1.1	Boot ROM Command Mode	80
5.1.2	Boot ROM Commands.....	81
5.2	Login and Logout	82
5.3	CLI Commands	82
5.3.1	System Commands	82
5.3.2	Physical Interface Commands.....	85
5.3.3	Route Commands.....	86
5.3.4	Bridge Commands.....	88
5.3.5	SNMP.....	96
5.3.5	Filters Commands.....	103
5.3.6	Security Commands	107
6	IP Addresses, Network Masks, and Subnets	113
6.1	IP Addresses.....	113
6.1.1	Structure of an IP address.....	113
6.1.2	Network classes.....	115
6.2	Subnet masks	116
7	Troubleshooting.....	118
7.1	Diagnosing problems using IP utilities	118
7.1.1	ping	118

	7.1.2	nslookup.....	120
	7.2	Replacing defective fans	121
	7.3	Simple fixes	123
8		Glossary.....	125
9		Index.....	134

List of Figures

Figure 1.	GigaX L3 managed switch package contents.....	15
Figure 2.	Front panel	16
Figure 3.	Rear panel.....	18
Figure 4.	Overview of Hardware Connections	21
Figure 5.	Login and IP setup Screen.....	24
Figure 6.	Login Screen	25
Figure 7.	IP Setup.....	26
Figure 8.	Configuration manager login screen	27
Figure 9.	Home page.....	28
Figure 10.	Top Frame.....	29
Figure 11.	Expanded Menu List	30
Figure 12.	Management	32
Figure 13.	IP Setup.....	33
Figure 14.	Administration	34
Figure 15.	Firmware Upgrade	35
Figure 16.	Physical Interface.....	37
Figure 17.	Interfaces	39
Figure 18.	Static Route.....	41
Figure 19.	RIP.....	42
Figure 20.	Spanning Tree.....	44
Figure 21.	Link aggregation.....	46
Figure 22.	Mirroring page	47
Figure 23.	Static Multicast	48
Figure 24.	IGMP Snooping.....	49
Figure 25.	Traffic Control.....	50

Figure 26. Dynamic Address51

Figure 27. Static Address53

Figure 28. Tagged VLAN.....54

Figure 29. Default Port VLAN and CoS.....55

Figure 30. CoS Queue Mapping.....56

Figure 31. DHCP Snooping57

Figure 32. Community Table58

Figure 33. Host Table59

Figure 34. Trap Setting.....60

Figure 35. VACM Group61

Figure 36. VACM View62

Figure 37. USM User.....64

Figure 38. Filter Set.66

Figure 39. Filter Rule in MAC mode67

Figure 40. Filter Rule in IP mode.....67

Figure 41. Filter Attach69

Figure 42. Port Access Control.....71

Figure 43. Dial-In user72

Figure 44. RADIUS.....73

Figure 45. Traffic comparison.....75

Figure 46. Error group75

Figure 47. Historical Status76

Figure 48. Save Configuration.....77

Figure 49. CLI interface79

Figure 50. Boot ROM Command Mode.....80

Figure 51. SYS commands.....83

Figure 52. Using the ping utility 119

Figure 53. Using the nslookup utility..... 120

Figure 54. Loosening the thumbscrew 121

Figure 55. Removing the fan module 121
Figure 56. Detaching the fan from the module..... 122

List of Tables

Table 1. Front panel labels and LEDs..... 17
Table 2. Rear panel labels 18
Table 3. Technical specifications 18
Table 4. LED Indicators..... 22
Table 5. Port color description 29
Table 6. Commonly used buttons and icons..... 31
Table 7. Boot ROM commands..... 81
Table 8. IP address structure 114
Table 9. Troubleshooting 123

1 Introduction

Congratulations on becoming the owner of the ASUS GigaX L3 managed switch! You may now manage your LAN (local area network) through a friendly and powerful user interface.

This user guide tells you how to set up the GigaX L3 managed switch, and how to customize its configuration to get the most out of this product.

1.1 L3 managed features

- 24 10/100BASE-TX auto-sensing Fast Ethernet ports
- Two 10/100/1000BASE-T auto-sensing Gigabit Ethernet switching ports
- Two small form factor (SFP) Gigabit interface converter (GBIC) slots
- Automatic MDI/MDIX support for 10/100BASE-TX and 10/100/1000BASE-T ports
- Layer 3 switching for IP packets
- 2K IP address cache with hardware-accelerated forwarding
- Static route
- RIP v1, v2
- Compliant with 802.3u, 802.3z and 802.3ab specifications
- 802.1D transparent bridge/spanning tree protocol
- 802.1w RSTP (Rapid Spanning Tree Protocol)
- IEEE 802.1x authentication (with dynamic VLAN assignment)
- RADIUS (Remote Authentication Dial-in User Service)
- 8K MAC address cache with hardware-assisted aging
- 802.3x flow control
- 802.1Q-based tagged VLAN, up to 255 VLANs
- 802.1p class of service, 4 queues per port
- IGMP snooping support
- 802.3ad link aggregation (trunking), up to 6 trunk groups
- Port Mirroring
- Access Control List
- RMON: support 4 groups (1, 2, 3, 9)
- SNMP v1, v2, v3

- MIB-II
- Enterprise MIB for PSU, fan, and system temperature, voltage
- Telnet or SSH remote login
- FTP for firmware update and configuration backup
- DHCP snooping support
- Syslog support
- Command Line Interpreter through console , telnet and SSH
- Web GUI
- LEDs for port link status
- LEDs system, redundant power supply (RPS), and fan status

1.2 Conventions used in this document

1.2.1 Notations

- Acronyms are defined the first time they appear in text and in the glossary.
- For brevity, the GigaX switch is referred to as “the switch.”
- The terms *LAN* and *network* are used interchangeably to refer to a group of Ethernet-connected computers at one site.

1.2.2 Typography

- *Italics* are used to present the parameters for the command line interpreter.
- Boldface type text is used for items you select from menus and drop-down lists, and text strings you type when prompted by the program.

1.2.3 Symbols

This document uses the following icons to call your attention to specific instructions or explanations.



Note

Provides clarification or additional information on the current topic.



Definition

Explains terms or acronyms that may be unfamiliar to many readers. These terms are also included in the Glossary.



WARNING

Provides messages of high importance, including messages relating to personal safety or system integrity.

2 Getting to know the GigaX

2.1 Package contents

The GigaX switch package comes with the following items:

- 24-port L3 managed switch
- AC Power cord
- Null modem cable for console interface (DB9)
- Rack installation kit (two brackets with six #6-32 screws)
- USB cable for console interface
- Installation CD-ROM
- Quick installation guide

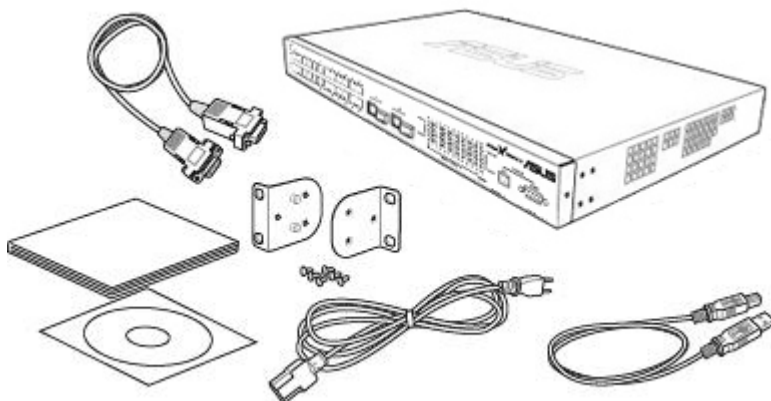

Figure 1. *GigaX L3 managed switch package contents*

2.2 Front Panel

The front panel includes LED indicators that show the system, RPS, fan, and port status.



Figure 2. Front panel

Table 1. Front panel labels and LEDs

Label	Color	Status	Description
SYSTEM	Green	On	Unit is powered on
		Flashing	Self-test, INIT, or downloading
	Amber	On	Abnormal temperature or voltage
	Off		No power
RPS	Green	On	The PSU is working properly and the switch has a good redundant power supply
	Amber	On	The PSU is abnormal and the switch is powered by RPS
	Off		No power at all (system LED is also off), RPS does not work properly or not installed (system LED is on)
FAN	Green	On	Both fans are working properly
	Amber	On	Both or either one of the fans stopped
10/100 ports	Green	On	Ethernet link is established
		Flashing	Data is being transmitted/received
	Off		No Ethernet link
	Amber	On	Link is present, but port is disabled either manually or by spanning tree
		Flashing	Port is in one of the STP blocking, listening and learning state
10/100/1000 port status	Green	On	Link (RJ-45 or SFP) is present; port is enabled
		Flashing	Data is being transmitted/received
	Off		No Ethernet link
	Amber	On	Link is present, but port is disabled either manually or by spanning tree
		Flashing	Port is in one of the STP blocking, listening and learning state
10/100/1000 port speed	Green	On	1000Mbps
	Amber	On	100Mbps
	Off		10Mbps
	Console USB		USB port for console management
	Console RS232		RS-232 serial port for console management

2.3 Rear Panel

The switch rear panel contains the ports for the data and power connections.



Figure 3. Rear panel

Table 2. Rear panel labels

No.	Label	Description
1	Power Connector	Connects to the supplied power cord
2	RPS	Redundant Power Supply connector
3	FAN1 – FAN2	Replaceable system fans

2.4 Technical specifications

Table 3. Technical specifications

Physical Dimensions	43.5mm(H) X 444 mm(W) X 265mm(D)		
Power	Input	Consumption	
	100-240V AC/2.5A 50-60Hz	< 90 watts	
Redundant Power Supply (RPS)	Input	Output	
	100-240V AC/1.8A 50-60Hz	12V DC/12.5A	
Environmental Ranges		Operating	Storage
	Temperature	-10 to 50 (14 to 122)	-40 - 70 (-40 to 158)
	Humidity	15 to 90%	0 to 95%
	Altitude	up to 10,000 ft (3,000m)	40,000 ft (12,000m)
Replaceable Fans	Dimensions	Voltage and Current	Speed:
	40 x 40 x 20 mm	12VDC, 0.13A	8200RPM

3 Quick start guide

This section provides the basic instructions to set up the GigaX environment. Refer also to the GigaX Series Installation Guide.

Part 1 shows you how to install the GigaX on a flat surface or on a rack.

Part 2 provides instructions to set up the hardware.

Part 3 shows you how to configure basic settings on the GigaX.

Obtain the following information from your network administrator before proceeding:

IP address for the switch

Default gateway for the network

Network mask for this network

3.1 Part 1 — Installing the hardware

Connect the device to the power outlet, and your computer or network.

Figure 4 illustrates the hardware connections.

3.1.1 Installing the switch on a flat surface

The switch should be installed on a level surface that can support the weight of the switches and their accessories. Attach four rubber pads on the marked location on the bottom of the switch.

3.1.2 Mounting the switch on a rack

1. Attach brackets to each side of the switch and make the posts insert to the switch.
2. Insert and tighten two screws to securely attach the bracket to the rack on each side.

3.2 Part 2 — Setting up the switch

Connect the device to the power outlet, and your computer or network. See Figure 4.

3.2.1 Connect the console port

For console management, use an RS232 (DB9) or a USB cable to connect the switch. If you want to use WEB interface, connect your PC to the switch using the Ethernet cable.

3.2.2 Connect to the computers or a LAN

You can use Ethernet cable to connect computers directly to the switch ports. You can also connect hubs/switches to the switch ports by Ethernet cables. You can use either the crossover or straight-through Ethernet cable to connect computers, hubs, or switches.



Use a twisted-pair Category 5 Ethernet cable to connect the 1000BASE-T port. Otherwise, the link speed can not reach 1Gbps.

3.2.3 Attach the RPS module

Connect your RPS module to the RPS jack and make sure the other end of the RPS is connected to the power cord. Connect to the power cord to a grounded power outlet.

3.2.4 Attach the power adapter

1. Connect the AC power cord to the POWER receptacle on the back of the switch and plug the other end of the power cord into a wall outlet or a power strip.
2. Check the front LED indicators with the description in Table 4. If the LEDs light up as described, the switch hardware is working properly.

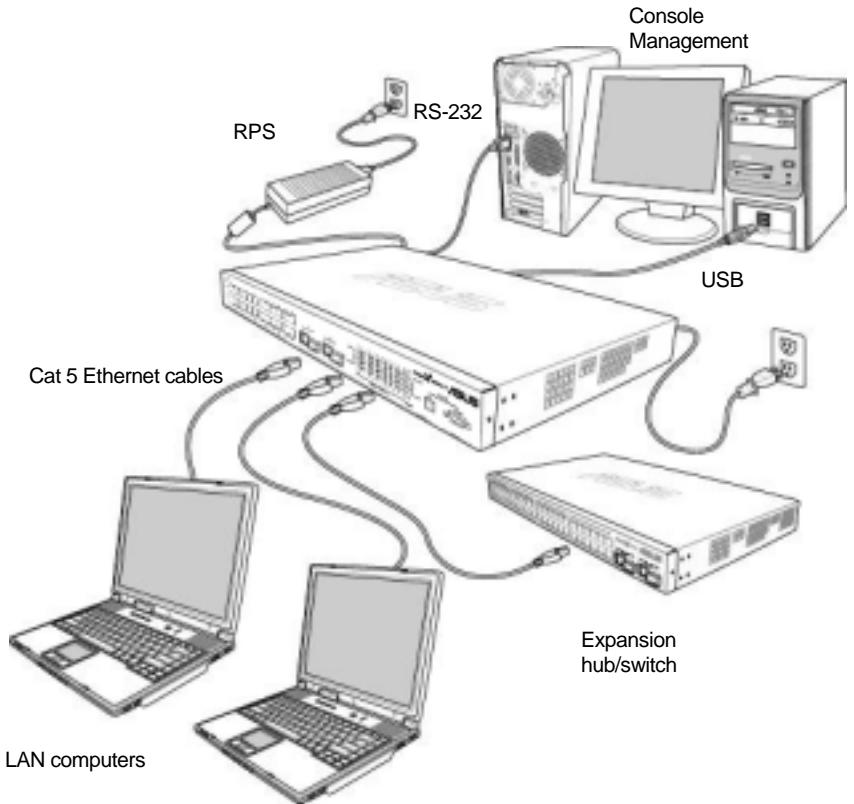

Figure 4. Overview of Hardware Connections

Table 4. LED Indicators

No.	LED	Description
1	System	Solid green indicates that the device is turned on. If this light is off, check if the power adapter if attached to the switch and plugged into a power source.
2	Switch ports [1] to [26]	Solid green indicates that the device can communicate with the LAN, or flashing when the device is sending or receiving data from your LAN computer.
3	RPS	Solid green indicates that the device has successfully installed an RPS module.
4	Fan	Solid green indicates that all fans work properly

3.3 Part 3 — Basic switch setting for management

After completing the hardware connections, configure the basic settings for your switch. You can manage the switch using the following methods:

- Web interface: the switch has a set of pages to allow you to manage it using Java[®]-enabled IE5.0 or higher version.
- Command Line Interface: use console port to manage the switch.

3.3.1 Setting up through the console port

1. Use the supplied crossover RS-232 cable to connect to the console port on the front of the switch. This port is a male DB-9 connector, implemented as a data terminal equipment (DTE) connection. Tighten the retaining screws on the cable to secure it on the connector. Connect the other end of the cable to a PC running terminal emulation software. e.g Hyper Terminal.
2. Use the supplied USB cable to connect to a PC. You have to install the USB driver from the switch CD-ROM before the USB can work properly. The USB drivers will simulate an additional COM port under Windows ME/2K/XP OS.

3. Make sure the settings of your terminal emulation software are as follows:
 - a) Choose the appropriate serial port number
 - b) Set the data baud rate to 9600
 - c) Set the data format to no parity, 8 data bits and 1 stop bit
 - d) No flow control
 - e) Set VT1000 for emulation mode
4. After setting up the terminal, you can see the prompt “(ASUS)%” on the terminal.
5. Type “login” to access the command line interface. The default user name is “admin”. Skip the password by pressing **<Enter>**.



You can change the password at any time through CLI (see section 5.3.1). To protect your switch from unauthorized access, you must change the default password as soon as possible.

6. Follow these steps to assign an IP address to the switch:
 - a) Type “I3 interface ip sw0 <your ip address> <your network mask>”. For example, if your switch IP is 192.168.10.1 and the network mask is 255.255.255.0. Then you should type “I3 interface ip sw0 192.168.10.1 255.255.255.0”.
 - b) If the switch has to be managed across networks, then a default gateway or a static route entry is required. Type “I3 route static add 0.0.0.0 <your network gateway IP> 0.0.0.0 1” as your default route entry, as shown in Figure 5.

```
(@SUS)% 7
Available commands are:
login          Log in the system
logout        Log out the current user

(@SUS)% login
user name: admin
password:

user 'admin' logged in

(@SUS)% 13 interface ip sw0 192.168.10.1 255.255.255.0
IP address set successfully

(@SUS)% 13 route static add 0.0.0.0 192.168.10.254 0.0.0.0 1
Route added successfully

Specific route is added successfully

(@SUS)%
(@SUS)%
```

Figure 5. Login and IP setup Screen

3.3.2 Setting up through the Web interface

To successfully connect your PC to the switch, your PC must have a valid IP in your network. Contact your network administrator to obtain a valid IP for the switch. If you wish to change the default IP address of the switch, follow section 3.3.1 to change the IP address. Since the switch does not support DHCP client function, a valid static IP for the switch is necessary to use Web interface.

1. It is not necessary to login Web interface at the first time to use Web interface because the default configuration for Web access authentication is disabled. To secure the system configuration, please enable the authentication function at the “**Administration**” page under “**System**” category. Skip step 2 if the authentication is disabled.
2. At any PC connected to the network that the switch can access , open your Web browser (Internet Explorer), and type the following URL in the address/location box, and press <Enter>:

http://192.168.1.1

This is the factory default IP address of the switch.

A login screen appears, as shown in Figure 6.



Figure 6. Login Screen

Enter your user name and password, and then click  to enter the Configuration Manager. Use the following defaults the first time you log into this interface:

Default User Name: admin
Default Password: (no password)



You can change the password at any time (see section 5.3.1 System Commands).

3. To setup a new IP address, click “**System**”, then “**IP Setup**” (see Figure 7). Fill in the IP address, network mask and default gateway, then click .
4. If your new address is different from the default, the browser can not update the switch status window or retrieve any page. This is normal. You have to retype the new IP address in the address/location box, and press **<Enter>**. The WEB link returns.
5. To enable authentication for Web access, click “**Administration**” on the menu list, then select “**Enabled**” to start the protection.

A login window appears immediately after you click . See the figures on the next page.



Figure 7. IP Setup

4 Management with the Web Interface

The switch provides Web pages that allow switch management through the Internet. The program is designed to work best with Microsoft Internet Explorer® 5.5, or later versions. **NOTE:** Netscape is not supported.

4.1 Log into Web user interface

1. From a PC, open your web browser, type the following in the web address (or location) box, and press **<Enter>**:

http://192.168.1.1

This is the factory default IP address for the switch. A login screen displays, as shown in Figure 8.



Figure 8. Configuration manager login screen

Log in is not required if you don't enable access authentication

2. Enter your user name and password, then click . Use the following defaults the first time you log into the program. You can change the password at any time through CLI interface (see section 5.3.1).

Default User Name: admin

Default Password: <no password>

The home page appears each time you log into the program. (See Figure 9.)



Figure 9. Home page

4.2 Functional layout

Typical web page consists of three separate frames. The top frame has a switch logo and front panel as shown in Figures 10. This frame remains on the top of the browser window all the times and updates the LED status periodically. See Table 4 for the LED definitions. See Table 5 for the color status description.



Figure 10. Top Frame

Table 5. Port color description

Port Color	Description
Green port	Ethernet link is established
Black	No Ethernet link
Amber port	Link is present but port is disabled manually or by spanning tree

Clicking on the port icon of the switch displays the port configuration in the lower right frame.

The left frame, a menu frame as shown in Figure 11, contains all the features available for switch configuration. These features are grouped into categories, e.g. System, Bridge, etc. You can click on any of these to display a specific configuration page.

- System
 - * Management
 - * IP Setup
 - * Administration
 - * Reboot
 - * Firmware Upgrade
- * Physical Interface
- Route
 - * Interfaces
 - * Static Route
 - * RIP
- Bridge
 - * Spanning Tree
 - * Link Aggregation
 - * Mirroring
 - * Static Multicast
 - * IGMP Snooping
 - * Traffic Control
 - * Dynamic Addresses
 - * Static Addresses
 - * Tagged VLAN
 - * Default Port VLAN & CoS
 - * CoS Queue Mapping
 - * DHCP Snooping
- SNMP
 - * Community Table
 - * Host Table
 - * Trap Setting
 - * VACM Group
 - * VACM View
 - * USM User
- Filters
 - * Filter Set
 - * Filter Attach
- Security
 - * Port Access Control
 - * Dial-in User
 - * RADIUS
- Statistics Chart
 - * Traffic Comparison
 - * Error Group
 - * Historical Status
- * Save Configuration

Figure 11. Expanded Menu List

The above frame displays configuration pages or graphics for the statistics. See section 4.3 for details.







4.2.1 Menu navigation tips

- To expand a group of related menus, click on the corresponding group name. The ▶ sign will change to ▼ after expansion.
- To contract a group of related menus: click on the corresponding group name. The ▶ sign will appear next to the group name.
- To open a specific configuration page, click on the desired menu item.

4.2.2 Commonly used buttons and icons

The following table describes the function for each button and icon used in the application.

Table 6. Commonly used buttons and icons

Button/Icon	Function
	Stores any changes you have made on the current page.
	Adds the existing configuration to the system, e.g. a static MAC address or a firewall ACL rule and etc.
	Modifies an existing entry
	Modifies the existing configuration in the system, e.g. a static route or a filter ACL rule and etc.
	Deletes the selected item, e.g. a static route or a filter ACL rule and etc.
	Re-displays the current page with updated statistics or settings.

4.3 System Pages

System pages include management, IP setup, administration, reboot, and firmware update function.

4.3.1 Management

The **Management** page contains the following information:

Model Name: product name

MAC Address: switch MAC address

System Name: user assigned name to identify the system (editable)

System Contact (editable)

System Location (editable)

To save any changes and make it effective immediately, click

OK

Use **Reload** to refresh the setting, as shown in Figure 12.



Figure 12. Management

4.3.2 IP Setup

The switch supports only static IP assignment. The **IP Setup** page contains the following editable information:

VLAN ID: Specify a VLAN ID to system management interface. It is necessary to be within the same VLAN for management usages.

IP Address: Assign a static IP address to the switch management interface.

Network Mask

Default Gateway



To save any changes and make it effective immediately, click . Use  to refresh the setting, as shown in Figure 13.



Figure 13. IP Setup

4.3.3 Administration

The **Administration** page allows you enable or disable the authentication for web user by *password protection*. The default setting for web access does not require any authentication.

To save any changes and make it effective immediately, click .

Use  to refresh the setting, as shown in Figure 14. When you enable the password protection, you have to login again immediately.



You can change the password at any time through the CLI interface.



Figure 14. Administration

4.3.4 Reboot

The **Reboot** page contains a  button. Clicking the button reboots the system.



Rebooting the system stops the network traffic and terminates the Web interface connection.

4.3.5 Firmware Upgrade

The **Firmware** page contains the following information:

Hardware Version: shows the hardware revision number.

Boot ROM Version: shows the version of the boot code

Firmware Version: shows the current running firmware version. This number will be updated after the firmware update.

Enter the firmware location into the firmware space directly, or click

 to choose the file name of the firmware from prompt window.

Click  to update the switch firmware. See Figure 15 for reference.



Clicking the upload button loads the assigned firmware to the switch, then reboot system after a successful firmware update. You have to re-login to Web interface again



Figure 15. Firmware Upgrade

4.4 Physical Interface

The **Physical Interface** displays the Ethernet port status in real time. You can configure the port in following fields:

Port: select the port to configure

Admin: disable/enable the port

Mode: set the speed and duplex mode

Flow Control: enable/disable 802.3x flow control mechanism

Port Status Window: displays the following information for each port

- a) Link status: the link speed and duplex for an existing link, otherwise link is down
- b) State: the STP state
- c) Admin: the setting value to disable or enable the port
- d) Mode: the setting value for link speed and duplex mode
- e) Flow Control: the setting value to enable or disable 802.3x flow control mechanism

Select the corresponding port number and configure the port setting, then click on the  button. The field you change will update the content of the display window. However, the new settings do not take effect until the “*Save Configuration*” is executed.

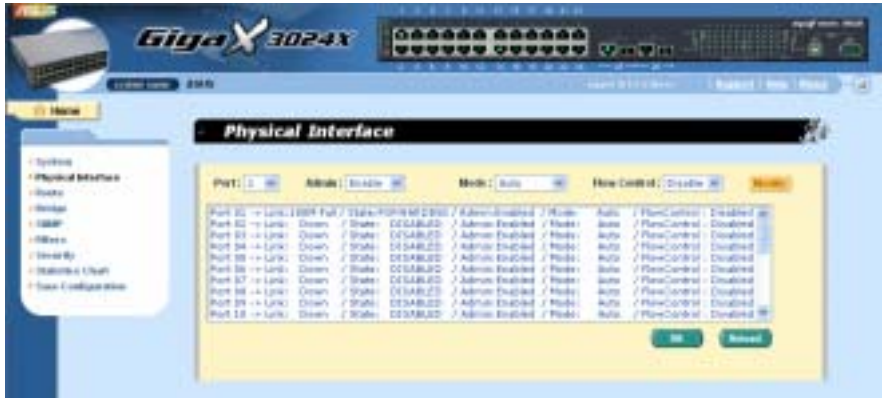

Figure 16. Physical Interface

4.5 Route

This command group offers L3 interface and route entry configuration

4.5.1 Interfaces

Generally, Layer 3/routed interfaces are used to route traffic between the VLAN, this is so-called inter-VLAN routing. That is, different VLANs exchange data with going through Layer 3 interfaces and need not an external router.

This switch performs Layer 3 switching only for IP protocol. To enable Layer 3 switching on a specific interface, the following information must be configured:

Name: the *UNIQUE* name used for managing Layer 3 interfaces under CLI console

Type: *VLAN* type interface is virtual interface, which is VLAN-bind; where *Port* type interface is routed port base. One of the interface types must be specified

VLAN: the interface associated VLAN (range 1-4000), this VLAN should have been created as well as assigned with port member in Layer 2. One VLAN ID can only be assigned to one interface

Routed port: where the traffic should be destined to. Routed port does not perform Layer 2 functions. Note that you cannot configure a mirror-to port, trunk port, or 802.1x authentication unauthorized (auto/force) port as a routed port simultaneously. Routed port will automatically become non-STP port when STP/RSTP process has been enabled

IP address: the interface IP address

Subnet mask: the interface subnet mask

Status: interface up/down (Layer 3 switching works only amongst the running up interfaces)

Select the corresponding interface and configure the interface parameters. To save any changes and make it effective immediately, click **OK**. Use **Reload** to refresh the setting. The field you changed will update the content in the display window.

By default, Layer 3 switching is disabled. You have to create and activate Layer 3 interface(s) before enable Layer 3 switching. Up to 32 Layer 3 interfaces can be created in this switch.

Interface "sw0" is the system interface, which is default created by the system and cannot be removed.

Check the **[Remove]** checkbox and click **OK** if you want to remove an interface from the select list.

Click **OK** to make the setting effective. Click **Reload** to refresh the settings to current value.



Figure 17. Interfaces

4.5.2 Static Route

Static routing is the simplest form of network routing. It makes available to a switch/router to forward packets from predetermined ports through a predictable path into and out of a network. Static routing is solid, but does not address to the fluctuation in the network, therefore, it might result in destination net unreachable.

To create a static route entry, you have to configure the following information:

Destination: Input destination IP address.



Netmask: Input subnet mask of the destination.

Gateway: Input gateway IP address.

Metric: Metric/cost for the destination (1-15).

Static routing is easy to set up and be managed particularly in small networks. But, it needs additional planning and management in advanced. Meanwhile, it does not scale well in large networks.

If a match is not found in the routing table for the destination IP address, then a default route is required. A default route is somehow called the "route of last resort". It is the last route tried when all other routes fail. Since routing has longest prefix match behavior, the default route has the fewest number of network bits matching and is therefore less specific. A default route is always configured with both '*Destination*' and '*Netmask*' as the value of '*0.0.0.0*'.

Click on  when you add a new static route and you will see the new added entry shows in the list. You can remove the existed route by clicking the button, then clicking on . The route added and removed will be saved in configuration file immediately.



Click  to make the setting effective. Click  to refresh the settings to current value.



Figure 18. Static Route

4.5.3 RIP

The Routing Information Protocol (RIP) is documented in [RFC 1058](#), [RFC 1388](#) and [RFC 1723](#). In short, RIP is a distance-vector routing protocol that exchange routing information using UDP packets.

RIP configuration includes the following information:

RIP process: enable/disable. RIP advertisements are sent and received only when the RIP process is enabled.

RIP version: v1/v2/both. To specify what RIP Version packets are to be sent and received.

RIP interfaces: To specify which routing entry should be advertised along the networks. Note that only the running up Layer 3 interface(s) (in *connected* status) will be able to advertise routing information, while the interface(s) in *disconnected* and *down* status will not.

By default, RIP process is disabled and two of RIP Versions are assigned for the switch. All Layer 3 interfaces are classified as RIP enabled interfaces.

Once the RIP process has been enabled, the current state of the active process will be displayed. You can click **Reload** to refresh the updated status.

Click **Modify** to change the RIP interfaces setting.

Click **OK** to make the setting effective.



Figure 19. RIP

4.6 Bridge

The **Bridge** page group contains most layer 2 configurations, like link aggregation, STP....etc..

4.6.1 Spanning Tree/Rapid Spanning Tree

The configuration page for Spanning Tree Protocol can disable and enable the feature in runtime. This page consists of three parts.

The first part shows the root information. It tells user the STP setting about the root switch.

The second part is the STP setting. The following options are available:

Disable/STP Enabled/RSTP Enabled: Turn the STP/RSTP off/on. When you turn the STP/RSTP on, STP/RSTP will use the following settings if the switch is the root switch.

Hello Time: the interval between the generation of configuration BPDU

Max Age: a timeout value to be used by all Bridges in the LAN

Forward Delay: a timeout value to be used by all bridges in the LAN

Bridge Priority: the switch priority in the LAN

The third part is the port setting. It contains a display window to show the current configuration for each port. You click  to change the port setting for STP/RSTP. The following fields are available:

Port: select the corresponding port to configure

Priority: the port priority in the switch. Low numeric value indicates a high priority. The port with lower priority is more likely to be blocked by STP if a network loop is detected. The valid value is from 0 to 240.

Cost: the valid value is from 1 to 200000000. The higher cost is more likely to be blocked by STP if a network loop is detected.

FastLink: make the port in forwarding state when a link comes up, then the port will participate STP resolutions.

Edge Port: All ports are set to be edge ports by default. Edge port becomes STP port when BPDU is received. Also, it takes very short time for an edge port to be in forwarding state.

Point to Point: Auto/Yes/No. A full duplex link is considered as a point to point link. Otherwise, it is a shared link. Point to point link may have less convergence time. Auto is recommended in most cases.

Click **OK** to effect the settings. Click **Reload** to refresh the settings to the current value.



Figure 20. Spanning Tree

4.6.2 Link Aggregation

The page configures the link aggregation group (port trunking). The switch can have 6 link aggregation groups.

Show Trunk: Select “Add a new Trunk” for a new created group. Or select an existed group to display on the following fields and port icons.

Port Selection Criterion: the algorithm to distribute packets among the ports of the link aggregation group according to source MAC address, destination MAC address, source and destination MAC address, source IP address, destination IP address, or source and destination IP address.



Name: the group name.

Trunk ID: a number to identify the trunk group besides the group name.

LACP: Enable/Disable LACP on selected trunk. LACP mode is fixed to be Active.

Remove Trunk: Remove the selected trunk.

Port Icons: these port icons are listed in a way like the front panel. You have to click on the icon the select the group members. The port can be removed from the group by clicking the selected port again.

Click  to make the setting send to the switch (HTTP server). Click  to refresh the settings to current value. To make the configuration effective, go to “*Save Configuration*” page, then click .

You have to check the runtime link speed and duplex mode to make sure the trunk is physically active. Go to *Physical Interface* and check the link mode in the runtime status window for the trunk ports. If all the trunk members are in the same speed and full duplex mode, then the trunk group is set up successfully. If one of the members is not in the same speed or full duplex mode, the trunk is not set correctly. Check the link partner and change the settings to have the same speed and full duplex mode for all the members of your trunk group.



- All the ports in the link aggregation group **MUST** operate in full-duplex mode at the same speed.
- All the ports in the link aggregation group **MUST** be configured in auto-negotiation mode or full duplex mode.
- This configuration will make the full duplex link possible. If you set the ports in full duplex force mode, then the link partner **MUST** have the same setting. Otherwise the link

aggregation could operate abnormally.

- All the ports in the link aggregation group MUST have the same VLAN setting.
- All the ports in the link aggregation group are treated as a single logical link. That is, if any member changes an attribute, the others will change too. For example, a trunk group consists of port 1 and 2. If the VLAN of port 1 changes, the VLAN of port 2 also changes with port 1.



Figure 21. Link aggregation

4.6.3 Mirroring

Mirroring, together with a network traffic analyzer, helps you monitor network traffics. You can monitor the selected ports for egress or ingress packets.

Mirror Mode: Enables or disables the mirror function for the selected group.

Monitor Port: Receives the copies of all the traffics in the selected mirrored ports.

GigaX 3024X has only one monitor port. The port can monitor 24 Fast Ethernet ports and two Gigabit ports.



The monitor port can not belong to any link aggregation group.

The monitor port can not operate as a normal switch port. It does not switch packets or do address learning.

Click **OK** to make the setting send to the switch (HTTP server). Click **Reload** to refresh the settings to current value.



Figure 22. Mirroring page

4.6.4 Static Multicast

This page can add multicast addresses into the multicast table. The switch can hold up to 256 multicast entries. All the ports in the group will forward the specified multicast packets to other ports in the group.

Show Group: selects “Add a new Group” to enter a new entry. Or select an existing group address to display

MAC Address: selects the multicast address

VLAN: selects the vlan group

CoS: assigns the priority for Class of Service



Click  to make the setting effective. Click  to refresh the settings to current value.



Figure 23. Static Multicast

4.6.5 IGMP Snooping

IGMP snooping helps reduce the multicast traffics on the network by allowing the IGMP snooping function to be turned on or off. When turned on, the switch snoops the IGMP packets and puts the new group into the multicast table. However, if the static entries occupy all 256 spaces, the IGMP snoop does not work normally. The switch only allows 256-layer 2 multicast group.



Figure 24. IGMP Snooping

4.6.6 Traffic Control



Traffic control prevents the switch bandwidth from flooding packets including broadcast packets, multicast packets and the unicast packets because of destination address lookup failure. The limit number is a threshold to limit the total number of the checked type packets. For example, if broadcast and multicast are enabled, the total traffic amount for those two types will not exceed the limit value. Click  to save the new configuration. To make the configuration effective, go to “Save Configuration” page, then click .



Figure 25. Traffic Control

4.6.7 Dynamic Addresses

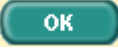
This page displays the result of dynamic MAC address lookup by port, VLAN ID, or specified MAC address. The dynamic address is the MAC address learned by switch, it will age out from the address table if the address is not learned again during the age time. User can set the age time by entering a valid number from 10 to 1,000,000 in seconds. Then click on

OK

to save the new age value. To make the configuration effective,

please go to “*Save Configuration*” page, then click on

Save

You can look up MAC addresses by checking the port, VLAN ID, or/and

MAC address, then click on

Query

. The address window will display the result of the query.



Figure 26. Dynamic Address

4.6.8 Static Addresses

You can add a MAC address into the switch address table. The MAC address added by this way will not age out from the address table. We call it static address.

MAC Address: enter the MAC address

VLAN ID: enter the VLAN ID that the MAC belongs

Port Selection: select the port which the MAC belongs

Discard: you can do packet filtering when the MAC address appears in the packets as destination address, source address, or either of them.

Click on the **Add** button when you create a new static MAC address by the above information. Then you will see the new added entry shows in the address window. You can remove the existed address by selecting the entry with the mouse, then clicking on **Remove**. The **Modify** button updates the existed MAC address entries. Click **OK** to save effective.

Click **Reload** to refresh the settings to current value. To make the configuration effective, please go to “save configuration” page, then click

Save



Figure 27. Static Address

4.6.9 Tagged VLAN

You can set up to 255 VLAN groups and show VLAN group in this page. There is a default VLAN created by the switch. It cannot be removed at all. This feature prevents the switch from malfunctions. You can remove any existed VLAN except the default VLAN.

You can assign the port to be a tagged port or an untagged port by toggling the port button. There are three types of button displays:

“U” type: untagged port that will remove VLAN tags from the transmitted packets.

“T” type: All packets transmitted from this port will be tagged.

“blank” type: This port is not a member of the VLAN group.

If one untagged port belongs to two or more VLAN groups at the same time, it will confuse the switch and cause flooding traffics. To prevent it, the switch only allows one untagged port belongs to one VLAN at the same time. That is, the untagged port belongs to the VLAN group which is called “PVID” and configured in the “Default Port VLAN & CoS” page. If you want to assign an untagged port from one VLAN to another, you have to remove it from the original VLAN, or change it to be tagged in the original VLAN first.

Show VLAN: select the existed VLAN to display or select “Add a new VLAN” to create a new VLAN group

Name: the VLAN name

DHCP Snoop: Enable or disable DHCP snooping on this VLAN.

VLAN ID: this field requires user to enter the VLAN ID when a new VLAN is created

Remove VLAN: Remove an existed VLAN. This field disappears in VLAN creation page.



Click on  to save the configuration. To make the configuration effective, go to “Save Configuration” page, then click on .



Figure 28. Tagged VLAN

4.6.10 Default Port VLAN and CoS

Some VLAN tag related field settings for each port are included in this page. It includes:

Port: select the port to configure

PVID: port-based VLAN ID. Every untagged packet received from this port will be tagged with this VLAN group ID

CoS (Class of Service) value: every untagged packet received from this port will be assigned to this CoS in the VLAN tagged

Click on **Modify** to change the content in the port list window. Click on **OK** to save the configuration. To make the configuration effective, go to "Save Configuration" page, then click **Save**.



Figure 29. Default Port VLAN and CoS

4.6.11 CoS Queue Mapping

The switch supports 4 egress queues for each port with a strict priority schedule. That is, each CoS value can map into one of the four queues. The queue 4 has the highest priority to transmit the packets. Click



to save the configuration. To make the configuration effective,



go to "Save Configuration" page, then click



Figure 30. CoS Queue Mapping

4.6.12 DHCP Snooping

DHCP snooping is a DHCP security feature that provides security by filtering untrusted DHCP messages and by building and maintaining a DHCP binding table. You can assign some ports to be trusted ports. The selected (trusted) port forwards the DHCP packets as a normal port, but the DHCP ACK packets will be dropped when the unselected (untrusted) port receives the packets.

DHCP Snooping is: To enable or disable DHCP snooping.

Click **OK** to make the setting send to the switch. Click **Reload** to refresh the settings to current value.



Figure 31. DHCP Snooping

4.7 SNMP

This group offers the SNMP configuration including **Community Table**, **Host Table**, and **Trap Setting**. To provide more secure management and access control, **SNMPv3** is supported.

4.7.1 Community Table

You can type different community names and specify whether the community has the privilege to do set action (write access) by checking the box. Click **OK** to save the configuration permanently or **Reload** to refresh the page.



Figure 32. Community Table

4.7.2 Host Table

This page links host IP address to the community name that is entered in **Community Table** page. Type an IP address and select the community name from the drop-down list. Click **OK** to save the configuration permanently or **Reload** to refresh the page.



Figure 33. Host Table

4.7.3 Trap Setting

By setting trap destination IP addresses and community names, you can enable SNMP trap function to send trap packets in different versions (v1 or v2c). Click **OK** to save the configuration permanently or **Reload** to refresh the page.



Figure 34. Trap Setting

4.7.4 VACM Group

VACM (View-based Access Control Model) Group is used to configure the information of SNMPV3 VACM Group.

Group Name: enter the security group name.

Read View Name: enter the Read View Name that the Group belongs. The related SNMP messages are Get, GetNext, GetBulk.

Write View Name: enter the Write View Name that the Group belongs. The related SNMP message is Set.

Notify View Name: enter the Notify View Name that the Group belongs. The related SNMP messages are Trap, Report.

Security Model: enter the Security Model Name that the Group belongs. Any is suitable for v1, v2, v3. USM is SNMPv3 related.

Security level: enter the Security level Name that the Group belongs. Only NoAuth, AuthNopriv, AuthPriv can be chosen.

Click on the **Add** when you create a new VACM group entry by the above information. Then you will see the new added entry shows in the group window. You can remove the existed group by selecting the entry with the mouse, then clicking on **Remove**. The **Modify** button updates the existed VACM Group entries. Click **OK** to save effective. Click **Reload** to refresh the settings to current value. To make the configuration effective, please go to "Save Configuration" page, then click on **Save**.



Figure 35. VACM Group

4.7.5 VACM View

VACM (View-based Access Control Model) View is used to view the information of SNMPV3 VACM Group.

View Name: enter the security group name.

View Type: enter the View Type that the View belongs. Included or Excluded when View Subtree matches the Oid in the SNMPv3 message.

View Subtree: enter the View Subtree that the View belongs. The Subtree is the Oid to match the Oid in the SNMPv3 message. The match is good when the subtree is shorter than the Oid in the SNMPv3 message.

View Mask: enter the View Mask that the View belongs. Each bit in the mask represents the digit between the dots of View Subtree from left side. Bit '0' means 'don't care'.

Click on the **Add** when you create a new VACM View entry by the above information. Then you will see the new added entry shows in the view window. You can remove the existed views by selecting the entry with the mouse, then clicking on **Remove**. The **Modify** button updates the existed VACM View entries. Click **OK** to save effective. Click **Reload** to refresh the settings to current value. To make the configuration effective, please go to "Save Configuration" page, then click on **Save**.



Figure 36. VACM View

4.7.6 USM User

USM (User-based Security Model) User is used to configure the information of SNMPV3 USM User.

Engine Id: enter the Engine Id that should match the ID in the Manager.

Name: enter Name combined with Engine ID that should match the Name and Engine ID in the Manager.

Auth Protocol: enter the Auth Protocol that Engine ID and Name belong. Only NoAuth, MD5, SHA1 can be chosen. If the NoAuth is chosen, there is no need to enter password.

Auth Password: enter the password that the Auth Protocol belongs. The password needs at least 8 characters or digits.

Priv Protocol: enter the Priv Protocol that Engine ID and Name belong. Only NoPriv, DES can be chosen. If the NoPriv is chosen, there is no need to enter password.

Priv Password: enter the password that the Priv Protocol belongs. The password needs at least 8 characters or digits.







Click on the  when you create a new USM User entry by the above information. Then you will see the new added entry shows in the User window. You can remove the existed User by selecting the entry with the mouse, then clicking on . The  button updates the existed USM User entries. Click  to save effective. Click  to refresh the settings to current value. To make the configuration effective, please go to "Save Configuration" page, then click on .



Figure 37. USM User



4.8 Filters



The switch can filter certain traffic types according to packet header information from Layer 2 to Layer 4. Each filter set includes a couple of rules. You have to attach the filter set to certain ports to make the filter work.

4.8.1 Filter Set

You can create a filter set by giving a name, ID and a mode of rules. The switch defines two modes of rules, one is MAC mode and the other is IP mode. Only the same mode of rules can bundle together to form a filter set. Each mode has different fields to configure. For example, you can use IP mode rule to filter FTP packets.

When you click on the **Filter Set**, the Filter Set page appears (Figure 38).

First, create a filter set by typing a name and ID, then clicking on . Second, click on the  button to select the set you want to edit or remove.

Third, click on  to enter the rule page as Figure 40, or click on  to remove the filter set. You have to follow the rules to make a valid filter set.

- One set consists of a type of rules. The rules having the same fields to filter packets belong to one type. For example, two rules filter packets with two destination IP addresses, then they are the same type. But a rule filtering source IP address does not belong to the same type.
- Four types of rules can apply to ports at the same time. If there are more than four types, the system automatically disables the rules.



Figure 38. Filter Set

The *Filter Rule* page provides options for rule modes, one is MAC rule (Figure 39) and the other is IP rule (Figure 40). If you did not enter the MAC address in the blank box, it means the rule doesn't care the MAC value. In IP rule setup, you can enter any of the 5 types, source IP, destination IP, protocol, source application port and destination application port. The **Action** field determines if the packet should be dropped or forwarding when it matches the rule. If a packet matches two rules with different action, the packet will follow the rule showed first in the rule list.





Figure 39. Filter Rule in MAC mode



Figure 40. Filter Rule in IP mode

4.8.2 Filter Attach

A filter set is idle if you did not attach it to any ingress or egress port. Use the Filter Attach page to attach a filter set to ingress and egress ports.

Click  to save the configuration. To make the configuration effective, go to the "Save Configuration" page, then click , or click on  to refresh the page.

To attach a filter set to ports:

- Attach to all ports: the filter set applies to all the ports of the system.
- Attach to certain ports: you can specify the ingress ports and egress port to be applied.
- Detach from all ports: remove all the filters from the attached ports.



You may not detach certain ports after issuing an "Attach All" command. If you wish to detach ports, use the "Detach All" command.

Once the filter set is attached to the ingress ports and egress ports, it will filter the packets according to the ingress port, egress port, and the packet fields in the rules. For example, a set with a single rule to filter out destination MAC address 00:10:20:30:40:50 is attached to ingress port 1 and egress port 2. A packet with destination MAC 00:10:20:30:40:50 from port 1 is not switched to port 2, but it is possible to go to other ports except port 2 in flooding situation.



Figure 41. Filter Attach

4.9 Security

The switch has the 802.1x port-based security feature. Only authorized hosts are allowed to access the switch port. Traffic is blocked for hosts failed to authenticate themselves. The authentication service is provided by a RADIUS server or the local database in the switch.

The switch also supports dynamic VLAN assignment through 802.1x authentication process. The VLAN information for the users/ports should be configured in the authentication server properly before enabling this feature.

4.9.1 Port Access Control

Port Access Control is used to configure various 802.1x parameters. 802.1x uses either RADIUS server or local database to authenticate port users.

The first part is the Bridge (Global) settings:

- **Reauthentication:** Once enabled, the switch will try to authenticate the port user again when the re-authentication time is up.
- **Reauthentication Time:** If 'Reauthentication' is enabled, this is the time period the switch uses to re-send authentication request to the port user.(see above)
- **Authentication Method:** RADIUS or Local database can be used to authenticate the port user.
- **Quiet Period:** If authentication failed either from RADIUS or local database, the switch waits upon this time period before sending another authentication request to the port user.
- **Retransmission Time:** If the port user failed to respond to authentication request from the switch, the switch waits upon this time period before sending another authentication request to the port user.
- **Max Reauthentication Attempts:** Retry count if the port user failed to respond to authentication requests from the switch.

The second part is the port settings. Please click  when you're done with the modifications.

- **Port:** Specify which port to configure.

- **Multi-host:** If enabled, ALL hosts connected to the selected port are allowed to use the port if ONE of the hosts passed the authentication. If disabled, only ONE host among other hosts passed the authentication is allowed to use the port.
- **Authentication Control:** If 'force_authorized' is selected, the selected port is forced authorized. Thus, traffic from all hosts is allowed to pass. Otherwise, if 'force_unauthorized' is selected, the selected port is blocked and no traffic can go through. If 'Auto' is selected, the behavior of the selected port is controlled by 802.1x protocol. All ports should be set to 'Auto' under normal conditions.
- **Guest VLAN:** Specify a guest VLAN to clients that are not 802.1x-capable.

Click **OK** to make the settings permanent. Click **Reload** to refresh the settings to current value.



Figure 42. Port Access Control

4.9.2 Dial-In User

Dial-in User is used to define users in the local database of the switch.

- User Name: New user name.
- Password: Password for the new user.
- Confirm Password: Enter the password again.
- Dynamic VLAN: Specify the VLAN ID assigned to the 802.1x-authenticated clients.

Click **Add** to add the new user. Click **Modify** when you're done with the modifications. Click **Remove** when you want to remove the selected user. Click **OK** to make the settings permanent. Click **Reload** to refresh the settings to current value.



Figure 43. Dial-In user

4.9.3 RADIUS

In order to use external RADIUS server, the following parameters are required to be setup:

- Authentication Server IP: The IP address of the RADIUS server.
- Authentication Server Port: The port number for the RADIUS server is listening to.
- Authentication Server Key: The key is used for communications between GigaX and the RADIUS server.
- Confirm Authentication Key: Re-type the key entered above.



The VLAN of the RADIUS server connected to the switch must be the same as the VLAN of the system management interface.

Click **OK** to make the settings permanent. Click **Reload** to refresh the settings to current value.



Figure 44. RADIUS

4.10 Statistics Chart

The **Statistics Chart** pages provide network flow in different charts. You can specify the period time to refresh the chart. You can monitor the network traffic amount in different graphic chart by these pages. Most MIB-II counters are displayed in these charts.

Click **Refresh Rate** to set the period for retrieving new data from the switch. You can differentiate the statistics or ports by selecting **Color**. Finally, click on **Draw** to let the browser to draw the graphic chart. Each new **Draw** will reset the statistics display.

4.10.1 Traffic Comparison

This page shows the one statistics item for all the ports in one graphic chart. Specify the statistics item to display and click **Draw**, the browser will show you the update data and refresh the graphic periodically.

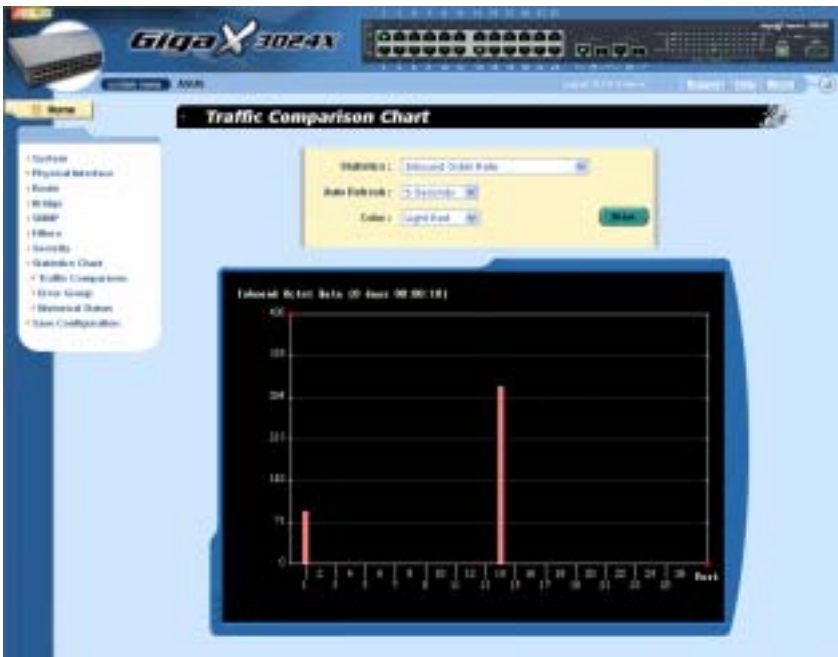

Figure 45. Traffic comparison

4.10.2 Error Group

Selecting the **Port** and display **Color**, then clicking **Draw**, the statistics window shows you all the discards or error counts for the specified port. The data is updated periodically.



Figure 46. Error group

4.10.3 Historical Status

You can display information for different ports and statistics items in this chart. Since this shows the history of the statistics information, the line chart keeps the old data even it is refreshed.



Figure 47. Historical Status

4.11 Save Configuration

To save configuration permanently, you have to click . The setting also takes effective after a successful save.

Sometimes you may want to reset the switch configuration, you can click on  to reset the configuration file to factory default. Of course, a system reboot will follow this restoration process.



You will lose all the configurations when you choose to restore the factory default configurations.



Figure 48. Save Configuration

5 Console Interface

This chapter describes how to use console interface to configure the switch. The switch provides RS232 and USB connectors to connect your PC. Use a terminal emulator on your PC such as HyperTerminal and command line interpreter to configure the switch. You have to set up the terminal emulator with baud rate 9600, 8 bit data, no parity, and 1 stop bit, and no flow control.

Once you enter CLI mode, type “?” will display all available command help messages. This is very useful when you are not familiar with the CLI commands. The CLI mode times out when idle for 10 minutes. You have to login again to enter CLI mode after the timeout.

All the CLI commands are case sensitive. In order to make them easier to use, you can enter into different category by typing the full command, then this category becomes your working category. Thereafter, you don't have to type “sys” before any sub-commands. For example, “sys” is a command category including a lot of sub-commands. You don't have to type “sys” for the sub-commands once you change your working category to “sys” by typing “sys”. The prompt will become “(system name)sys%” when your working category is “sys”.

5.1 Power On Self Test

POST is executing during the system booting time. It tests system memory, LED and hardware chips on the switchboard. It displays system information as the result of system test and initialization. You can ignore the information until the prompt, "(ASUS)%", appears (see Figure 49).

```
>>>>> ASUS OS Initialization Start(Phase 2)
System Parameters Reloading ..... [ DONE ]
Layer 2 Functions Initialization ..... [ DONE ]
Layer 3 Interfaces Initialization ..... [ DONE ]
CLI Command Tree Initialization ..... [ DONE ]
In-ROM File System Initialization ..... [ DONE ]
RADIUSd Initialization ..... [ DONE ]
SNMPd Initialization ..... [ DONE ]
Telnetd Initialization ..... [ DONE ]
HTTPd Initialization ..... [ DONE ]
FTPD Initialization ..... [ DONE ]
SSHD Initialization ..... [ DONE ]
RIP Initialization ..... [ DONE ]

ASUS OS Initialization Success.

Step 5
>>>>> Entering CCM(CLI Command Mode) ...

Login is required!
|ASUS|%
```

Figure 49. CLI interface

5.1.1 Boot ROM Command Mode

During the POST process, you can enter a “Boot ROM Command” mode by pressing <ENTER> key as shown in Figure 50.

Figure 50 shows dual images in the switch. One firmware is in Slot 0 and the other firmware is in Slot 1. The later version will be selected to boot the system automatically.

Enter the “?” key to show the help messages for all available commands.



Although the commands are helpful in some situation, we STRONGLY suggest users not to use them if you don't know the command function.

```
>>>>> Boot Module Processing
SDRAM Read/Write Test ..... DONE
Loading(Decompressing) Boot Module Image ..... DONE
Destination Address ..... 0x80700000
Image Size ..... 190768 bytes
Starting Address ..... 0x80700000

>>>> Switch Software Information <<<<
Boot ROM Version ..... 2.1.2
Boot ROM Build Date ..... Jan 17 2005 - 14:39:55
(S0)Firmware Address ..... 0xb0100000
(S0)Firmware Age ..... 0x5c
(S0)Firmware Status ..... PASS
(S0)Firmware Version ..... 2.1.3
(S0)Firmware Creation Date ..... 1/28/2005 2:22:27
(S0)Firmware Size ..... 1778848 bytes
(S0)Firmware Checksum ..... 0xca40
(S0)Firmware Starting Address ..... 0x80010020
(S0)Firmware Web Files Size ..... 217834 bytes
(S1)Firmware Address ..... 0xb0400000
(S1)Firmware Age ..... 0x5b
(S1)Firmware Status ..... PASS
(S1)Firmware Version ..... 2.1.3a
(S1)Firmware Creation Date ..... 1/27/2005 13:30:23
(S1)Firmware Size ..... 1778848 bytes
(S1)Firmware Checksum ..... 0xca40
(S1)Firmware Starting Address ..... 0x80010020
(S1)Firmware Web Files Size ..... 217834 bytes

[ASUS OS Boot]:
```

Figure 50. Boot ROM Command Mode

5.1.2 Boot ROM Commands

Type “?” in the boot mode to display the valid commands list.

Table 7. Boot ROM commands

Command	Parameters	Usage	Notes
d	Address [,length]	Dump memory contents by giving address and length.	
p	NONE	Display current boot parameters	
g	NONE	Execute firmware, enter CLI mode	
b	0 or 1 or a	Dual image support. You can choose the firmware to execute by giving a slot ID, or use “a” for auto select. Auto-select will execute the most updated firmware. This is the default setting	When you fail in firmware update, you can use this command to boot up the switch using the old firmware. Change it back to auto-select mode after successfully updating the firmware.
s	0, 1, 2, 3	Set the console baud rate. 0: 9600bps 1:38400bps 2:57600bps 3:115200bps	You have to set up the terminal emulator with the same baud rate to make the work
x	NONE	Upload firmware to the switch	It is slow to update firmware by the console port. If you lost network connection to switch, you can still update firmware in this way
r	NONE	Toggle the safe mode	When a configuration file is corrupt or you forget your password, use safe mode to enter CLI mode. Your configuration file is lost in this mode. You need to restore your configuration, or re-configure the system

5.2 Login and Logout

By typing “**login**” to enter the CLI mode, you have to give a valid user name and password. As the first time login, you can enter “**admin**” as the user name and bypass the password. For security reason, please change the user name and password after login. Once you forget the use name and password, you may contact ASUS support team or erase the whole configuration file in the **Boot ROM Command** mode. If you take the second choice, the whole system configuration is lost at the same time. That is, you have to configure the switch again.

You type “*logout*” to leave the CLI mode safely. This action allows you to secure the CLI mode. The next user has to do login again with authorized user name and password.

5.3 CLI Commands

The switch provides CLI commands for all managed functions. The command uses are listed in the categories as the WEB management interface. This way, you can follow the instructions and set up the switch correctly as easily as using WEB interface to configure the switch.

Always use “?” to get the available commands list and help.



Always use “/” to get back to the root directory.

Always use “..” to get back to the previous directory.

Type the command only to get help for the command

5.3.1 System Commands

[System Name]

Displays the given name of the switch. This is an RFC-1213 defined MIB object in System Group, and provides administrative information on the managed node.

CLI command : sys info name <*system name description*>

If you put a name in the name description field, the switch system name changes to the new one.

[System Contact]

Displays the detail information of contact about the switch. This is an RFC-1213 defined MIB object in System Group, and provides contact information on the managed node.

CLI command : `sys info contact <system contact description>`

If you put the contact description in the contact description field, the switch contact will change to the new one.

[System Location]

Displays the physical location of the switch. This is an RFC-1213 defined MIB object in System Group, and provides the location information on the managed node.

CLI command : `sys info location <system location description>`

Type in the location description in the location description field to change the location.

```
(R8US)X sys
(R8US)sysX ?
Available commands are:
/          Change to root directory
..         Change to parent directory
info/     System information commands
time/     System time commands
log/      System log commands
os/       Operating system commands
files/    System files commands
health/   System health commands
users/    Users management commands
web/      Web-authentication login setting
baud      Set console baud rate
reboot    Reboot the system
rebootinfo/ Reboot information

(R8US)sysX info name
Current system name is R8US

(R8US)sysX info name GX3024X
System name is set to GX3024X

(GX3024X)sysX
```

Figure 51. SYS commands

[VLAN ID]

Displays the VLAN ID for the switch. It is necessary to be within the same VLAN for management usages.

CLI command: I3 interface vlan sw0 <VLAN ID>

[IP Address]

Displays the static IP address for the switch. This IP address is used for manageable purpose, i.e. network applications such as, http server, SNMP server, ftp server , telnet server and SSH server of the switch are all using this IP address.

CLI command: I3 interface ip sw0 <IP address> <netmask>

[Network Mask]

Displays the subnet mask for the switch.

CLI command: I3 interface ip sw0 <IP address> <netmask>

[Default Gateway]

Displays the IP address of the default gateway. This field is necessary if the switch network contains one or more routers.

CLI command: I3 route static add <destination subnet/IP> <gateway> <netmask> <metric>

[Password Protection is] [Enabled/Disabled]

When the password protection is enabled, the web interface will request a user name and password authentication while user accesses the switch through the browser.

CLI command : sys web set <enable/disable>

[New Password]

[Verify Password]

The default user name is **admin**. By default, a password is not required. You may set a password by configuring these fields.

CLI command : sys users modify <user name, 'admin' by default>

user name (old user name, 'admin' by default): <new user name>

password (old password, no password by default): *<new password>*

[Reboot]

User can reboot the switch by issuing the reboot command.

CLI command: sys reboot

[Upload]

No CLI command for this function. Refer to Boot ROM commands for this function.

5.3.2 Physical Interface Commands

[Admin] [Enable/Disable]

Displays the port admin status, allow user to turn the port on or off.

CLI command : l2 port admin *<port number>* *<enable/disable>*

[Mode] [Auto/10M-Half/10M-Full/100M-Half/100M-Full/1G-Full]

Displays the current speed and duplex mode of the port. The speed and duplex mode can be automatically detected when auto-negotiation is enabled on a port.

CLI command : l2 port autoneg *<port number>* *<enable/disable>*

CLI command : l2 port speed *<port number>* *<10/100/1000>*

CLI command : l2 port duplex *<port number>* *<full/half>*

[Flow Control] [Enable/Disable]

Displays the IEEE802.3x flow control setting of a port. Note that this flow control is operating only in full duplex mode.

CLI command : l2 port flow *<port number>* *<enable/disable>*

[Reload]

Restores the previous port settings from the configuration file.

CLI command : sys l2 port retrieve

5.3.3 Route Commands

[Show L3 Interfaces]

Displays all L3 interfaces settings.

CLI command : l3 interface show *<trunk id>*

[Create L3 Interfaces]

User can create a new L3 interface by specify an unique interface name, the interface type (VLAN, virtual interface or Port, routed port), and its type member (VLAN ID or port ID).

CLI command : l3 interface create *<interface name>* [vlan *<vlan id>* / port *<port id>*]

[Set/Display L3 Interfaces IP address/netmask]

Displays the static IP address and subnet mask for an L3 interface. This IP address is used for IP routing as well as switch management.

CLI command : l3 interface ip *<interface name>* *<ip>* *<mask>*

[Start L3 Interfaces]

Bring up or activate an L3 interface.

CLI command : l3 interface start *<interface name>*

[Stop L3 Interfaces]

Shutdown or deactivate an L3 interface.

CLI command : l3 interface stop *<interface name>*

[Display Routes]

Display routing entries in the routing table.

CLI command : l3 route show

[Add Static Route]

Insert a static route entry into the routing table by giving the destination IP, gateway IP address, subnet mask and the metric.

CLI command : I3 route static add <dst> <gateway> <mask> <metric>

[Delete Static Route]

Delete a static route entry from the routing table.

CLI command : I3 route static add <dst> <gateway> <mask>

[Display RIP status]

Display current RIP status and its interfaces and routing information.

CLI command : I3 rip show

[Enable/Disable RIP]

Enable or disable RIP process in the switch. When RIP process has been enabled, it will advertise its routing information to its next hop switch/router. Meanwhile it will be able to receive and deal with RIP message broadcasted/multicast along the network. Default RIP process is disabled.

CLI command : I3 rip route <enable/disable>

[Set RIP version]

You can specify a RIP version for the RIP process to indicate what type of messages it can deal with. There are v1, v2 and both for selection. Default RIP version is set to both.

CLI command : I3 rip version <1/2/* for all>

[RIP-enabled interfaces]

All L3 interfaces are default set as RIP-enabled interface. When an interface is specified as RIP-enabled interface, it means that once the RIP process has been enabled, this interface will be able to participate in RIP functionalities.

CLI command : I3 rip interface add <interface name/* for all>

[RIP-disabled interfaces]

You can specify an L3 interface as RIP-disabled interface if you do not want this interface to deal with any RIP message, either incoming or outgoing.

CLI command : I3 rip interface remove <interface name/* for all>

5.3.4 Bridge Commands

[Spanning Tree is] [STP Enabled/ RSTP Enabled/ Disabled]

Allows user to specify whether the switch participates in the Spanning Tree Protocol (STP/ RSTP).

CLI command : I2 stp start <stp / rstp>

CLI command : I2 stp stop

[Hello Time]

[Forward Delay]

[Max Age]

[Bridge Priority]

Displays the current STP/RSTP bridge parameters setting.

CLI command : I2 stp bridge set

Hello Time (1..10 seconds):[old Hello Time] <new Hello Time>

Max Age (6..40 seconds):[old Max Age] <new Max Age>

Forward Delay (4..30 seconds):[old Forward Delay] <new Forward Delay>

Bridge Priority (0..61440):[old Bridge Priority] <new Bridge Priority>

[Priority]

[Path Cost]

[Edge Port]

[Point-to-point]

Displays the current STP/RSTP ports parameters setting.

CLI command : I2 stp port set

Port Settings (all,...):[all] <select a port number, or just type 'all' to iteratively config>

Port <port number> Priority (0..240):[old port Priority] <new port Priority>

Port <port number> Path Cost (1..200000000):[old port Path Cost] <new port Path Cost>

Port <port number> EdgePort (yes/no):[old port EdgePort] <new port EdgePort >

Port <port number> Point-to-Point (yes/no/auto):[old port Point-to-Point] <new port Point-to-Point >

[Reload]

Restores the previous saved settings from configuration file.

CLI command : l2 stp retrieve

CLI command : l2 stp bridge retrieve

CLI command : l2 stp port retrieve

[Show Trunk]

Displays a specific trunk group settings. User can create a new trunk group by specify a unique trunk ID, a trunk name description, the port selection criterion (rtag), LACP mode (enabled or disable), and its trunk group member ports.

CLI command : l2 trunk show <trunk id>

[Create Trunk]

Creates a new trunk group by giving trunk ID, rtag, name, LACP mode and port numbers. The "rtag" is the packet distribution algorithm for the trunk group.

Rtag values and corresponding meanings:

1: select port by source MAC

2: select port by destination MAC

3: select port by source and destination MAC

4: select port by source IP

5: select port by destination IP

6: select port by source and destination IP

CLI command: I2 trunk create <trunk id> <rtag (1-6)> <trunk name>
<lacp (enable/disable)> <port list>

[Add/Remove Trunk]

Trunk group port members can be added to or removed from an existing trunk group.

CLI command : I2 trunk add <trunk id> <port list>

CLI command : I2 trunk remove <trunk id> <port list>

[LACP Action]

User can enable or disable LACP on a specific trunk group.

CLI command : I2 trunk lacp action <trunk id> <enable/disable>

[LACP System Priority]

User can assign the system priority for running LACP.

CLI command : I2 trunk lacp syspri <priority (1-65535)>

[LACP Port Priority]

User can assign the port priority for running LACP.

CLI command: I2 port lacppri <priority> <port list / * for all ports>[Reload]

Restores the previous saved settings of trunking from configuration file.

CLI command : I2 trunk retrieve

[Mirror Mode] [Enable/Disable]

[Monitor Port] [port number]

Displays the mirroring settings of the switch.

CLI command : I2 mirror create <monitor port no> <enable/disable>

CLI command : I2 mirror ingress <port list>

CLI command : l2 mirror egress *<port list>*

CLI command : l2 mirror remove *<ingress/egress> <port list>*

[Reload]

Restores the previous saved settings from configuration file.

CLI command : l2 mirror retrieve

[Show Multicast Group]

Displays the static multicast groups that are presented in the multicast group table.

CLI command: l2 mcast show

[Set Multicast Group]

Allows user to add or modify a static multicast group by specifying the MAC address, VLAN ID, Class of Service, VLAN port members, and its untagged port members. Note that MAC address and VLAN ID combination is formed as a unique entry in multicast group table.

CLI command: l2 mcast set

mac address [format: xx:xx:xx:xx:xx:xx]: *<multicast mac address>*

vlan id [1 by default]: *<vlan id>*

cos [0-7, 0 by default]: *<Class of Service >*

port list [format: 1 2 3 4-26/* for all ports]: *<vlan port list>*

untagged port list [format: 1 2 3 4-26/* for all ports]: *<untagged port list>*

[Remove Multicast Group]

Allows user to delete a static multicast group entry from multicast group table by given a MAC address and VLAN ID.

CLI command : l2 mcast delete

mac address [format: xx:xx:xx:xx:xx:xx]: *<multicast mac address>*

vlan id: <vlan id>

[Reload]

Restores the previous saved settings from configuration file.

CLI command : l2 mcast retrieve

[IGMP] [Enabled/Disabled]

Layer 2 IGMP snooping can be started or terminated by user if necessary.

CLI command : l2 igmp <start/stop>

[Reload]

Restores the previous saved settings from configuration file.

CLI command : l2 igmp retrieve

[Broadcast] [Enabled/Disabled]

[Multicast] [Enabled/Disabled]

[Destination Lookup Failure] [Enabled/Disabled]

User can limit the broadcast, multicast, and flooding (due to destination lookup failed) traffic rate by turning the traffic control on.

CLI command : l2 rate set <1: bcast/2: mcast/3: dlf> <enable/disable>

[Limit]

Displays the current rate limitation value of the switch. User can change this value by giving a new limit value. This value is applied to all of the traffic control mentioned above.

CLI command : l2 rate limit <limit rate>

[Reload]

Restores the previous saved settings from configuration file.

CLI command : l2 rate retrieve

[Aging Time]

User can set the ARL(Address Resolution Logic) entries aging time by setting the aging time value.

CLI command : `l2 arl age [aging time value]`

[Query by Port]

ARL entries existed in ARL table can be queried according to port number.

CLI command : `l2 arl port <port number>`

[Query by VLAN ID]

ARL entries existed in ARL table can be queried according to VLAN ID.

CLI command : `l2 arl vlan <vlan id>`

[Query by MAC Address]

ARL entries existed in ARL table can be queried according to MAC address.

CLI command : `l2 arl mac <mac address>`

[MAC Address]

[VLAN ID]

[Port Selection]

[Discard] [none/source/destination/source & destination]

User can add or modify a static ARL entry by specifying a MAC address, VLAN ID, port number, trunk ID, and discard criteria.

CLI command : `l2 arl static <mac> <vlan id> <port no> <trunk id>
<discard: 0-3>`

[Remove]

Static ARL entries can be deleted by indicating the MAC address and its VLAN ID. These two-field combination is formed as unique entry in ARL table.

CLI command : `l2 arl delete <mac address> <vlan id>`

[Reload]

Restores the previous saved settings from configuration file.

CLI command : I2 arl retrieve

[Show VLAN]

Displays the existing VLAN information of the switch.

CLI command : I2 vlan show *<vlan id>*

[Name]

[VLAN ID]

Allows user to config the VLAN settings. User may create a new VLAN by giving a unique VLAN ID, a VLAN description name, and its port member list, note that the port member here is indicated as tagged port member. To specify a VLAN port member as untagged port, CLI command utportadd can achieve this purpose. User may use CLI command add or remove to further add some port members to a VLAN or exclude some existing port members from a VLAN.

CLI command : I2 vlan create *<vlan id>* *<vlan name>* *<port list>*

CLI command : I2 vlan add *<vlan id>* *<port list>*

CLI command : I2 vlan remove *<vlan id>* *<port list>*

CLI command : I2 vlan utportadd *<vlan id>* *<untagged port list>*

[DHCP Snoop]

Enable or disable DHCP snooping on this VLAN.

CLI command : I2 dhcpsnoop enable *<vlan id list>*

CLI command : I2 dhcpsnoop disable *<vlan id list>*

[Remove VLAN]

Allows user to completely destroy an existing VLAN.

CLI command : I2 vlan delete *<vlan id>*

[Retrieve]

Restores the previous saved settings from configuration file.

CLI command : `l2 vlan retrieve`

[PVID]

Sets the default VLAN for a port by giving a VLAN ID and its associated port member list.

CLI command : `l2 port vlan <vlan id, 4000 to disable the port-based vlan> <port list> [CoS Value]`

Sets the Class of Service for a port by assigning it a priority (with range of 0-7) criteria value.

CLI command : `l2 port priority <CoS> <port list>`

[Retrieve]

Restores the previous saved settings from configuration file.

CLI command : `l2 port retrieve`

[Priority] [CoS Queue]

Allows user to map the CoS priority (with range of 0-7) for a buffer queue (total of 4, with queue ID of 1-4).

CLI command : `l2 cos map <queue id (1-4)> <cos (0-7)>`

[Retrieve]

Restores the previous saved settings from configuration file.

CLI command : `l2 cos retrieve`

[DHCP Snooping]

Enable or disable DHCP snooping on specific VLAN.

CLI command : `l2 dhcpsnoop enable <vlan id list>`

CLI command : `l2 dhcpsnoop disable <vlan id list>`

[Add/Remove Trusted Port]

Allows user to add or remove specific ports for DHCP snooping.

CLI command : l2 dhcpsnoop add *<port list>*

CLI command : l2 dhcpsnoop remove *<port list>*

[Retrieve]

Restores the previous saved settings from configuration file.

CLI command : l2 dhcpsnoop retrieve

5.3.5 SNMP

[Community Name] [Set]

A community entry contains a community description string and a set of privileges. Get privilege are turned on by default, and user can specify whether to give it the Set Privilege while create a new entry.

CLI command : snmp community add

New community string: *<new community string>*

Get privileges: [y, always turn on by default]

Set privileges? (y/n):[n] *<set privilege, y for 'yes'; n for 'no'>*

CLI command : snmp community set

User can modify a community entry in the table by reassigning its community string and privileges.

Community entry (table index): *<entry id to config>*

Community string (old community string): *<new community string>*

This action will modify all hosts with community string from '*old community*' to '*new community*'.

Are you sure? (y/n):[y] *<y for 'yes'; n for 'no'>*

Get privileges: [y, always turn on by default]

Set privileges? (y/n):[n] *<set privilege, y for 'yes'; n for 'no'>*

CLI command : snmp community delete

Allows user to delete a community entry from community table.

Community entry (table index): <entry id to delete>

This action will delete all hosts in community string with '*delete community*'.

Are you sure? (y/n):[y] <y for 'yes'; n for 'no'>

[Retrieve]

Restores the previous saved settings from configuration file.

CLI command : snmp community retrieve

[Host IP Address] [Community]

A host entry contains a host IP address, network mask and its dedicated community string.

CLI command : snmp host add

Host IP/Subnet: <IP address>

Netmask: <netmask>

Community: <community string>

CLI command : snmp host set

User can modify a host entry in the table by reassigning its allowed IP address, network mask and community string.

Host table entry (table index): <entry id to config>

Host IP/Subnet (old IP address): <new IP address>

Netmask (old netmask): <new netmask>

Community (old community string): <new community string>

CLI command : snmp host delete

Allows user to delete a host entry from host table.

Entry id (table index): <entry id to delete>

[Retrieve]

Restores the previous saved settings from configuration file.

CLI command : snmp host retrieve

[Trap Version] [v1/v2c]

[Destination]

[Community for Trap]

A trap entry contains SNMP version (currently support version 1 and version 2c), a destination IP address and the remote community string.

CLI command : snmp trap add

SNMP version? (1/2c):[1, by default] <snmp version>

Destination IP: <IP address>

Community: <community string>

CLI command : snmp trap set

User can modify a trap entry in the table by reassigning its SNMP version, destination IP address and community string.

Trap table entry (table index): <entry id to config>

SNMP version? (1/2c):[old snmp version] <new snmp version>

Destination IP (old IP address): <new IP address>

Community (old community string): <new community string>

CLI command : snmp trap delete

Allows user to delete a trap entry from trap table.

Trap table entry (table index): **<entry id to delete>**

[Retrieve]

Restores the previous saved settings from configuration file.

CLI command : snmp trap retrieve

[Group Name]

[Read View Name]

[Write View Name]

[Notify View Name]

[Security Model]

[Security level]

A VACM (View-based Access Control Model) Group entry contains a group name, read view name, write view name, notify view name, security model, security level and context match.

CLI command : snmp snmpv3 access add

Group Name: <group name string>

Security Model [0/1/2/3](any/v1/v2c/usm): <security model>

Security Level [1/2/3](noauth/authnopriv/authpriv): <security level>

Context Match [0/1](inexact/exact): <context match>

Read View Name: <read view name string>

Write View Name: <write view name string>

Notify View Name: <notify view name string>

CLI command : snmp snmpv3 access set

User can modify a VACM entry in the Group by reassigning its allowed group name, read view name, write view name, notify view name, security model, security level and context match.

Group Name: (old group name string) <new group name string>

Security Model [0/1/2/3](any/v1/v2c/usm): (old security model) <new security model>

Security Level [1/2/3](noauth/authnopriv/authpriv): (old security level) <new security level>

Context Match [0/1](inexact/exact): (old context match) <new context match>

Read View Name: (old read view name string) <new read view name string>

Write View Name: (old write view name string) <new write view name string>

Notify View Name: (old notify view name string) <new notify view name string>

CLI command : snmp snmpv3 access delete

Allows user to delete a VACM entry from VACM group.

Access entry: <entry id to delete>

[Retrieve]

Restores the previous saved settings from configuration file.

CLI command : snmp snmpv3 access retrieve

[View Name]

[View Type]

[View Subtree]

[View Mask]

VACM (View-based Access Control Model) View is used to view the information of SNMPV3 VACM Group. A VACM View entry contains a view name, view type, view subtree and view mask.

CLI command : snmp snmpv3 view add

View Name: <view name string>

View Subtree [oid]: <view subtree>

View Mask: <view mask>

View Type[1/2](included/excluded): <view type>

CLI command : snmp snmpv3 view set

User can modify a VACM View entry in the table by reassigning its allowed view name, view type, view subtree and view mask.

View Name: (old view name string) <new view name string >

View Subtree [oid]: (old view subtree) <new view subtree>

View Mask: (old view mask) <new view mask >

View Type[1/2](included/excluded): (old view type) <new view type >

CLI command : snmp snmpv3 view delete

Allows user to delete a VACM View entry.

View entry: <entry id to delete>

[Retrieve]

Restores the previous saved settings from configuration file.

CLI command : snmp snmpv3 view retrieve

[Engine Id]

[Name]

[Auth Protocol]

[Auth Password]

[Priv Protocol]

[Priv Password]

USM (User-based Security Model) User is used to configure the information of SNMPV3 USM User. A USM User entry contains an engine Id, name, auth protocol, auth password, priv protocol and priv password.

CLI command : snmp snmpv3 usmuser add

EngineId: *<engine id string >*

Name: *<user name string >*

AuthProtocol [oid]: *<auth protocol oid string >*

AuthPassword: *<auth password string>*

Priv Protocol [oid]: *<priv protocol oid string >*

Priv Password: *<priv password string >*

CLI command : snmp snmpv3 usmuser set

User can modify a USM User entry in the table by reassigning its allowed engine Id, name, auth protocol, auth password, priv protocol and priv password.

EngineId: (old engine id string) *<new engine id string >*

Name: (old user name string) *< new user name string >*

AuthProtocol [oid]: (old auth protocol oid string) *< new auth protocol oid string >*

AuthPassword: (old auth password string) *< new auth password string>*

Priv Protocol [oid]: (old priv protocol oid string) *< new priv protocol oid string >*

Priv Password: (old priv password string) *< new priv password string >*

CLI command : snmp snmpv3 view delete

Allows user to delete a USM User entry.

USM user entry: *<entry id to delete>*

[Retrieve]

Restores the previous saved settings from configuration file.

CLI command : snmp snmpv3 usmuser retrieve

5.3.5 Filters Commands

[New]

Creates a new filter set with specifying a unique ACL ID and its description name.

CLI command : filter set new <acl id> <acl name>

[Remove]

User can delete a filter set by indicating the ACL ID.

CLI command : filter set delete <acl id>

[Edit]

[Rule Mode] [MAC Rule]

[Action] [Permit/Deny]

[Source MAC]

[Destination MAC]

[Add]

User can add a new MAC address rule associated to a filter set. These filter rule works with ICMP, TCP or UDP protocols with action of permit or deny. User can also specify the MAC address (source or destination) of the filter rule by using CLI command dstmac and srcmac.

CLI command : filter rule new <set id> <rule id> <protocol: ICMP/TCP/UDP/any> <action: permit/deny>

CLI command : filter rule dstmac <set id> <rule id> <type: (any/[mac address])>

CLI command : filter rule srcmac <set id> <rule id> <type: (any/[mac address])>

[Rule Mode] [IP Rule]

[Action] [Permit/Deny]

[Source IP] [Type/IP, Mask]

[Destination IP] [Type/IP, Mask]

[Source Port] [Type/Port]

[Destination Port] [Type/Port]

[Protocol] [ICMP/TCP/UDP/ANY]

[Add]

User can add a new IP rule associated to a filter set. These filter rule works with ICMP, TCP or UDP protocols with permit or deny options. User can also specify the IP address (source or destination) and port number of the filter rule using the CLI command `dstip/srcip` and `dstport/srcport`, respectively.

CLI command : `filter rule new <set id> <rule id> <protocol: ICMP/TCP/UDP/any> <action: permit/deny>`

CLI command : `filter rule dstip <set id> <rule id> <type: (any/[ip] [subnet])>`

CLI command : `filter rule srcip <set id> <rule id> <type: (any/[ip] [subnet])>`

CLI command : `filter rule dstport <set id> <rule id> <type: (any/[port])>`

CLI command : `filter rule srcport <set id> <rule id> <type: (any/[port])>`

[Rule Mode] [MAC Rule]

[Action] [Permit/Deny]

[Source MAC]

[Destination MAC]

[Modify]

Allows user to modify the MAC filter rule.

CLI command : filter rule modify <set id> <rule id> <protocol: ICMP/TCP/UDP/any> <action: permit/deny>

CLI command : filter rule dstmac <set id> <rule id> <type: (any/[mac address])>

CLI command : filter rule srcmac <set id> <rule id> <type: (any/[mac address])>

[Rule Mode] [IP Rule]

[Action] [Permit/Deny]

[Source IP] [Type/IP, Mask]

[Destination IP] [Type/IP, Mask]

[Source Port] [Type/Port]

[Destination Port] [Type/Port]

[Protocol] [ICMP/TCP/UDP/ANY]

[Modify]

Allows user to modify the IP filter rule.

CLI command : filter rule modify <set id> <rule id> <protocol: ICMP/TCP/UDP/any> <action: permit/deny>

CLI command : filter rule dstip <set id> <rule id> <type: (any/[ip] [subnet])>

CLI command : filter rule srcip <set id> <rule id> <type: (any/[ip] [subnet])>

CLI command : filter rule dstport <set id> <rule id> <type: (any/[port])>

CLI command : filter rule srcport <set id> <rule id> <type: (any/[port])>

[Rule Mode] [MAC Rule]

[Action] [Permit/Deny]

[Source MAC]

[Destination MAC]

[Delete]

Allows user to delete the MAC filter rule.

CLI command : filter rule delete <set id> <rule id>

[Rule Mode] [IP Rule]

[Action] [Permit/Deny]

[Source IP] [Type/IP, Mask]

[Destination IP] [Type/IP, Mask]

[Source Port] [Type/Port]

[Destination Port] [Type/Port]

[Protocol] [ICMP/TCP/UDP/ANY]

[Delete]

Allows user to delete the MAC filter rule.

CLI command : filter rule delete <set id> <rule id>

[Rule List]

Displays the filter set and filter rule configurations.

CLI command : filter rule show <set id> <rule id>

Attach

Attach a filter set to ingress/egress ports to enable the filter function.

[Filter ID]

Displays the filter configurations.

CLI command : filter show

[Ingress Port]

Applies a filter set to an ingress port.

CLI command : filter apply ingress <filter set id> <any/none/[port number]>

[Egress Port]

Applies a filter set to an egress port.

CLI command : filter apply egress <filter set id> <any/none/[port number]>

[Retrieve]

Restores the previous saved settings from configuration file.

CLI command : filter retrieve

5.3.6 Security Commands

[Reauthentication]

Allows user to enable or disable periodic reauthentication.

CLI command : security dot1x bridge reauth <enable / disable>

[Reauthentication Time]

Allows user to set up the reauthentication time.

CLI command : security dot1x bridge reauthtime <reauthentication time (1-4294967295 sec)>

[Authentication Method]

Allows user to set up the authentication method (RADIUS or Local database).

CLI command : security dot1x bridge authmeth <type (1:local 2:radius)>

[Quiet Period]

Allows user to set up the quiet period.

CLI command : security dot1x bridge quietperiod <quiet period (1-65535 sec)>

[Retransmission Time]

Allows user to set up the retransmission time.

CLI command : security dot1x bridge retxttime <retransmission time (1-65535 sec)>

[Max Reauthentication Attempts]

Allows user to set up the max number of the reauthentication attempts.

CLI command : security dot1x bridge reauthmax <max reauthentication attempts (1-10)>

[Multi-host]

Allows user to enable or disable Multi-host on some specific ports.

CLI command : security dot1x port multihost <enable/disable><port list/*>

[Authentication Control]

Allows user to set up the authentication control of some specific ports.

CLI command : security dot1x port authctrl <type (1: force_authorized 2:force_unauthorized 3: auto)><port list/*>

[Guest VLAN]

Allows user to set up the guest VLAN ID of some specific ports.

CLI command : security dot1x bridge port guestvlan <vlan id (0:no guest vlan)> <port list/*>

[Retrieve]

Restores the previous saved settings from configuration file.

CLI command : security dot1x retrieve

[User Name]

[Password]

[Confirm Password]

[Dynamic VLAN]

Create users in the local database of the switch for 802.1x authentication. A user entry contains a user name, password and dynamic VLAN.

CLI command : security dialinuser create

User Name: <user name string>

Password: <password string>

Confirm Password: <confirm password string>

Dynamic VLAN: <dynamic VLAN>

CLI command : security dialinuser remove <user name/*>

Allows user to delete a user entry from the local database.

CLI command : security dialinuser modify <user name/*>

Allows user to modify a user entry from the local database. It contains a user name, password and dynamic VLAN.

User Name: <new user name string>

Password: <new password string>

Confirm Password: <new confirm password string>

Dynamic VLAN: <new dynamic VLAN>

[Retrieve]

Restores the previous saved settings from configuration file.

CLI command : security dialinuser retrieve

[Authentication Server IP]

[Authentication Server Port]

[Authentication Server Key]

[Confirm Authentication Key]

Allows user to config the RADIUS server IP, server port and server key .

CLI command : security radius set

authentication server ip <ip/none>: (old server ip)<new server ip >

authentication server port <port/default>: (old server port)<new server port>

authentication server key <key/none>: <server key>

confirm authentication key <key/none>: <confirm server key>

[Retrieve]

Restores the previous saved settings from configuration file.

CLI command : security radius retrieve

[Generate SSH key]

Allows user to generate SSH keys. SSH (Secure SHell) is a protocol for remotely logging into a machine via a shell. It is very similar in functionality to telnet, however unlike telnet, all data between the client and server is encrypted. The encryption provides protection against various network security risks. Currently, our switch supports SSH protocol version 2 and allows one login at a time. Two pairs of SSH keys will be created in system flash storage. The pairs of keys are RSA and DSA public/private keys respectively.

CLI command : security sshkey start

[Reset SSH key]

Reset SSH keys to default value.

CLI command : security radius default

[Show Generating Status]

Show the SSH key generating status. It will display “success” or “SSH keys generated fail” or “system is generating keys ...”.

CLI command : security sshkey show

Miscellaneous Commands

sys uptime: show the time since the system boot up.

sys date: show the current date and time

sys settime: set the current time

sys files config backup: backup configuration files

sys files config default: restore factory default configuration files

sys baud: set console baud rate

net ping: ping remote host

I3 route show: display the entries in the routing table

6 IP Addresses, Network Masks, and Subnets

6.1 IP Addresses



This section pertains only to IP addresses for IPv4 (version 4 of the Internet Protocol). IPv6 addresses are not covered.

This section assumes basic knowledge of binary numbers, bits, and bytes. For details on this subject, see Appendix 6.

IP addresses, the Internet's version of telephone numbers, are used to identify individual nodes (computers or devices) on the Internet. Every IP address contains four numbers, each from 0 to 255 and separated by dots (periods), e.g. 20.56.0.211. These numbers are called, from left to right, field1, field2, field3, and field4.

This style of writing IP addresses as decimal numbers separated by dots is called *dotted decimal notation*. The IP address 20.56.0.211 is read "twenty dot fifty-six dot zero dot two-eleven."

6.1.1 Structure of an IP address

IP addresses have a hierarchical design similar to that of telephone numbers. For example, a 7-digit telephone number starts with a 3-digit prefix that identifies a group of thousands of telephone lines, and ends with four digits that identify one specific line in that group.

Similarly, IP addresses contain two kinds of information.

Network ID

Identifies a particular network within the Internet or intranet

Host ID

Identifies a particular computer or device on the network

The first part of every IP address contains the network ID, and the rest of the address contains the host ID. The length of the network ID depends on the network's *class* (see following section). Table 7 shows the structure of an IP address.

Table 8. IP address structure

	Field1	Field2	Field3	Field4
Class A	Network ID	Host ID		
Class B	Network ID		Host ID	
Class C	Network ID			Host ID

Following are examples of valid IP addresses:

Class A: 10.30.6.125 (network = 10, host = 30.6.125)

Class B: 129.88.16.49 (network = 129.88, host = 16.49)

Class C: 192.60.201.11 (network = 192.60.201, host = 11)

6.1.2 Network classes

The three commonly used network classes are A, B, and C. (There is also a class D but it has a special use beyond the scope of this discussion.) These classes have different uses and characteristics.

Class A networks are the Internet's largest networks, each with room for over 16 million hosts. Up to 126 of these huge networks can exist, for a total of over 2 billion hosts. Because of their huge size, these networks are used for WANs and by organizations at the infrastructure level of the Internet, e.g. your ISP.

Class B networks are smaller but still quite large, each being able to hold over 65,000 hosts. There can be up to 16,384 class B networks in existence. A class B network might be appropriate for a large organization such as a business or government agency.

Class C networks are the smallest, only able to hold 254 hosts at most, but the total possible number of class C networks exceeds 2 million (2,097,152 to be exact). LANs connected to the Internet are usually class C networks.

Some important notes regarding IP addresses:

The class can be determined easily from field1:

field1 = 1-126: Class A

field1 = 128-191: Class B

field1 = 192-223: Class C

(field1 values not shown are reserved for special uses)

A host ID can have any value except all fields set to 0 or all fields set to 255, as those values are reserved for special uses.

6.2 Subnet masks



A *mask* looks like a regular IP address, but contains a pattern of bits that tells what parts of an IP address are the network ID and what parts are the host ID: bits set to 1 mean "this bit is part of the network ID" and bits set to 0 mean "this bit is part of the host ID."

Subnet masks are used to define *subnets* (what you get after dividing a network into smaller pieces). A subnet's network ID is created by "borrowing" one or more bits from the host ID portion of the address. The subnet mask identifies these host ID bits.

For example, consider a class C network 192.168.1. To split this into two subnets, you would use the subnet mask:

255.255.255.128

It's easier to see what's happening if we write this in binary:

11111111. 11111111. 11111111.10000000

As with any class C address, all of the bits in field1 through field 3 are part of the network ID, but note how the mask specifies that the first bit in field 4 is also included. Since this extra bit has only two values (0 and 1), this means there are two subnets. Each subnet uses the remaining 7 bits in field4 for its host IDs, which range from 0 to 127 (instead of the usual 0 to 255 for a class C address).

Similarly, to split a class C network into four subnets, the mask is:

255.255.255.192 or 11111111. 11111111. 11111111.11000000

The two extra bits in Field 4 can have four values (00, 01, 10, 11), so there are four subnets. Each subnet uses the remaining six bits in field4 for its host IDs, ranging from 0 to 63.

Sometimes a subnet mask does not specify any additional network ID bits, and thus no subnets. Such a mask is called a *default subnet mask*. These masks are:



Class A: 255.0.0.0
Class B: 255.255.0.0
Class C: 255.255.255.0

These are called *default* because they are used when a network is initially configured, at which time it has no subnets.

7 Troubleshooting

This section gives instructions for using several IP utilities to diagnose problems. A list of possible problems with suggestion actions is also provided.

All the known bugs are listed in the release note. Read the release note before you set up the switch. Contact Customer Support if these suggestions do not resolve the problem.

7.1 Diagnosing problems using IP utilities

7.1.1 ping

Ping is a command you can use to check whether your PC can recognize other computers on your network and the Internet. A ping command sends a message to the computer you specify. If the computer receives the message, it sends messages in reply. To use it, you must know the IP address of the computer with which you are trying to communicate.

On Windows-based computers, you can execute a ping command from the Start menu. Click the Start button, and then click Run. In the Open text box, type a statement such as the following:

ping 192.168.1.1

Click  You can substitute any private IP address on your LAN or a public IP address for an Internet site, if known.

If the target computer receives the message, a Command Prompt window appears as shown in Figure 52.

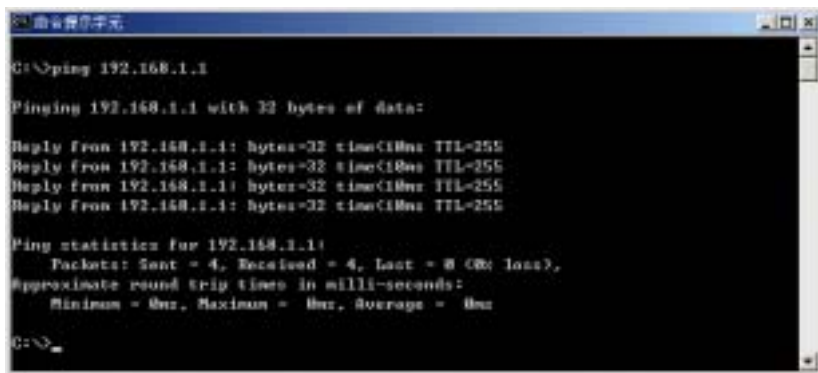

```
C:\>ping 192.168.1.1

Pinging 192.168.1.1 with 32 bytes of data:

Reply from 192.168.1.1: bytes=32 time<10ms TTL=255
Reply from 192.168.1.1: bytes=32 time<10ms TTL=255
Reply from 192.168.1.1: bytes=32 time<10ms TTL=255
Reply from 192.168.1.1: bytes=32 time<10ms TTL=255

Ping statistics for 192.168.1.1:
    Packets: Sent = 4, Received = 4, Lost = 0 (0% loss),
    Approximate round trip times in milli-seconds:
        Minimum = 0ms, Maximum = 0ms, Average = 0ms

C:\>
```

Figure 52. Using the ping utility

If the target computer cannot be located, you will receive the message “Request timed out.”

Using the ping command, you can test whether the path to the switch is working (using the pre-configured default LAN IP address 192.168.1.1) or another address you assigned.

You can also test whether access to the Internet is working by typing an external address, such as that for www.yahoo.com (216.115.108.243). If you do not know the IP address of a particular Internet location, you can use the nslookup command, as explained in the following section.

From most other IP-enabled operating systems, you can execute the same command at a command prompt or through a system administration utility.

7.1.2 nslookup

You can use the nslookup command to determine the IP address associated with an Internet site name. You specify the common name, and the nslookup command looks up the name on your DNS server (usually located with your ISP). If that name is not an entry in your ISP's DNS table, the request is then referred to another higher-level server, and so on, until the entry is found. The server then returns the associated IP address.

On Windows-based computers, you can execute the nslookup command from the Start menu. Click the Start button, then click Run. In the Open text box, type the following:

nslookup

Click . A Command Prompt window displays with a bracket prompt (>). At the prompt, type the name of the Internet address you are interested in, such as www.absnews.com.

The window displays the associate IP address, if known. See Figure 53.

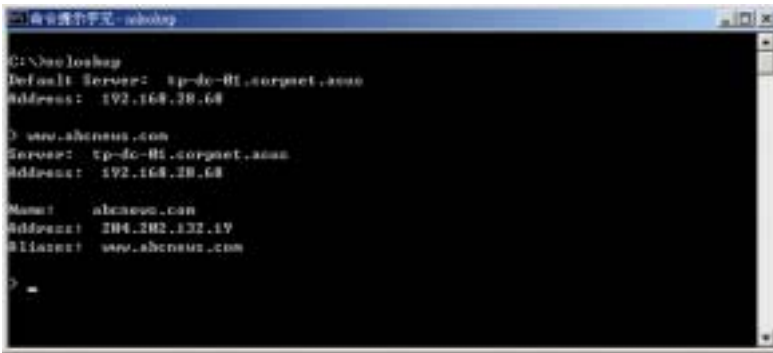

Figure 53. Using the nslookup utility

There may be several addresses associated with an Internet name. This is common for web sites that receive heavy traffic; they use multiple, redundant servers to carry the same information.

To exit from the nslookup utility, type **exit** and press **<Enter>** at the command prompt.

7.2 Replacing defective fans



Turn off the power of the switch when you remove the fan module on the rear side of the switch.

When any one of the switch fans (located on the rear panel) becomes defective, you can easily replace it following these steps.

1. Unlock the fan module by loosening the thumbscrew that secures it to the rear panel.

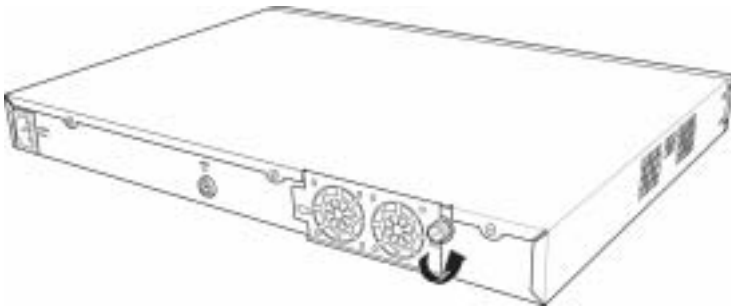

Figure 54. Loosening the thumbscrew

2. Carefully pull the module out as shown.

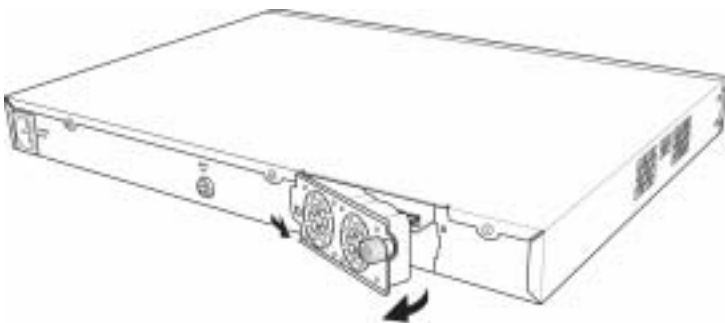

Figure 55. Removing the fan module

3. Carefully pull the two power cables from the fan connectors.
4. Loosen the screws that secure the fan to the module. Remove the defective fan.

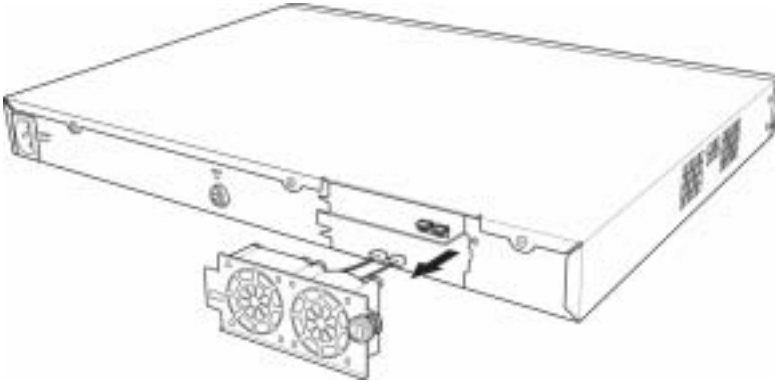

Figure 56. Detaching the fan from the module

5. Fasten the new fan with the screws that you removed earlier. Make sure that the fan cable is near the bottom of the module.
Follow the same steps to replace the other fan.
6. Connect the fan cables to the PCB. Make sure that the fan cables are connected to the correct fan connector. FAN 1 is on the left side when you are facing the rear panel.
7. Insert the fan module to the switch chassis until it fits in place. Make sure that the fan power cables are not caught between the fan module and chassis.
8. Secure the fan module to the chassis with the thumbscrew. Check around the fan module to make sure no cable is caught between the chassis and the fan module.

Fan specifications

Dimensions: 40 x 40 x 20 mm

Voltage and Current: 12VDC, 0.13A

Speed: 8200RPM

7.3 Simple fixes

The following table lists some common problems that you may encounter when installing or using the switch, and the suggested actions to solve the problems.

Table 9. Troubleshooting

Problem	Suggested Action
LEDs	
SYSTEM LED does not light up after the switch is turned on.	Verify if the power cord is securely connected to the switch and a wall socket/power strip.
RPS LED does not light up after a redundant power supply is attached.	<ol style="list-style-type: none"> 1. Verify if the RPS cable is securely connected to the RPS connector and a wall socket/power strip. 2. Make sure that the RPS meets with the standards provided in the RPS section.
FAN LED is amber blinking	Check the fans on the back of the switch. If any of the fans is defective, refer to section 7.2 to replace the fan.
Fast Ethernet Link LED does not illuminate after an Ethernet cable is attached.	<ol style="list-style-type: none"> 1. Verify if the Ethernet cable is securely connected to your LAN switch/hub/PC and to the switch. Make sure the PC and/or hub/switch is turned on. 2. Verify if your cable is sufficient for your network requirements. A 100 Mbps network (100BaseTx) should use cables labeled Cat 5. 10Mbit/sec cables may tolerate lower quality cables.
Network Access	
PC cannot access another host in the same network	<ol style="list-style-type: none"> 1. Check the Ethernet cabling is good and the LED is green. 2. If the port LED is amber, check if this port is disabled. You may experience a disconnected network in a short period (around 1 minute) if you just turned on the STP.
PCs cannot display web configuration pages.	<ol style="list-style-type: none"> 1. The switch is powered up and the connecting port is enabled. The factory default IP for the switch is 192.168.1.1. 2. Verify your network setup in your PC for this information. If your PC does not have a valid route to access the switch, change the switch IP to an appropriate IP that your PC can access. 3. Ping "switch IP" from the PC, if it still fails, repeat step 2. 4. If ping is successful but the web configuration still fails, connecting PC through the console port by a RS232 or USB, check if any filter rule or static MAC address is set to block the WEB traffics.

Problem	Suggested Action
Web Configuration Interface	
<p>You forgot/lost your WEB Configuration Interface user ID or password.</p>	<ol style="list-style-type: none"> <li data-bbox="322 180 954 236">1. If you have not changed the password from the default, try using "admin" as the user ID and bypassing password. <li data-bbox="322 244 954 292">2. Login to console mode through RS232 or USB, use "sys user show" to display the lost information
<p>Some pages do not display completely</p>	<ol style="list-style-type: none"> <li data-bbox="322 308 954 411">1. Verify that you are using Internet Explorer v5.5 or later. Netscape is not supported. Support for Javascript® must be enabled in your browser. Support for Java® may also be required. <li data-bbox="322 419 954 491">2. Ping the switch IP address to see if the link is stable. If some ping packets fail, check your network setup to make sure a valid setting.
<p>Changes to Configuration are not being retained.</p>	<p>Be sure to click on  button in the Save Configuration page to save any changes.</p>
Console Interface	
<p>Cannot show the texts on the terminal emulator.</p>	<ol style="list-style-type: none"> <li data-bbox="322 638 954 686">1. The factory default baud rate is 9600, no flow control, 8 bit data, no parity check and stop bit is one. <li data-bbox="322 694 954 742">2. Change your terminal emulator setup to this number. If you are using USB to connect the switch, install the USB driver first. <li data-bbox="322 750 954 782">3. Check if the cable is good.

8 Glossary

10BASE-T	A designation for the type of wiring used by Ethernet networks with a data rate of 10 Mbps. Also known as Category 3 (CAT 3) wiring. <i>See also data rate, Ethernet.</i>
100BASE-T	A designation for the type of wiring used by Ethernet networks with a data rate of 100 Mbps. Also known as Category 5 (CAT 5) wiring. <i>See also data rate, Ethernet.</i>
1000BASE-T	A designation for the type of wiring used by Ethernet networks with a data rate of 1000 Mbps.
binary	The "base two" system of numbers, that uses only two digits, 0 and 1, to represent all numbers. In binary, the number 1 is written as 1, 2 as 10, 3 as 11, 4 as 100, etc. Although expressed as decimal numbers for convenience, IP addresses in actual use are binary numbers; e.g., the IP address 209.191.4.240 is 11010001.10111111.00000100.11110000 in binary. <i>See also bit, IP address, network mask.</i>
bit	Short for "binary digit," a bit is a number that can have two values, 0 or 1. <i>See also binary.</i>
bps	bits per second
CoS	Class of Service. Defined in 802.1Q, the value range is from 0 to 7.

broadcast	To send data to all computers on a network.
download	To transfer data in the downstream direction, i.e., from the Internet to the user.
Ethernet	The most commonly installed computer network technology, usually using twisted pair wiring. Ethernet data rates are 10 Mbps and 100 Mbps. <i>See also 10BASE-T, 100BASE-T, twisted pair.</i>
filtering	To screen out selected types of data, based on filtering rules. Filtering can be applied in one direction (ingress or egress), or in both directions.
filtering rule	A rule that specifies what kinds of data the a routing device will accept and/or reject. Filtering rules are defined to operate on an interface (or multiple interfaces) and in a particular direction (upstream, downstream, or both).
FTP	File Transfer Protocol A program used to transfer files between computers connected to the Internet. Common uses include uploading new or updated files to a web server, and downloading files from a web server.
host	A device (usually a computer) connected to a network.
HTTP	Hyper-Text Transfer Protocol HTTP is the main protocol used to transfer data from web sites so that it can be displayed by web browsers. <i>See also web browser, web site.</i>

ICMP	<p>Internet Control Message Protocol</p> <p>An Internet protocol used to report errors and other network-related information. The ping command makes use of ICMP.</p>
IGMP	<p>Internet Group Management Protocol</p> <p>An Internet protocol that enables a computer to share information about its membership in multicast groups with adjacent routers. A multicast group of computers is one whose members have designated as interested in receiving specific content from the others. Multicasting to an IGMP group can be used to simultaneously update the address books of a group of mobile computer users or to send company newsletters to a distribution list.</p>
IGMP Snooping	<p>Snoop the IGMP packets on each port and associate the port with a layer 2 muticast group.</p>
Internet	<p>The global collection of interconnected networks used for both private and business communications.</p>
intranet	<p>A private, company-internal network that looks like part of the Internet (users access information using web browsers), but is accessible only by employees.</p>
IP	<p>See <i>TCP/IP</i>.</p>

IP address	<p>Internet Protocol address</p> <p>The address of a host (computer) on the Internet, consisting of four numbers, each from 0 to 255, separated by periods, e.g., 209.191.4.240. An IP address consists of a <i>network ID</i> that identifies the particular network the host belongs to, and a <i>host ID</i> uniquely identifying the host itself on that network. A network mask is used to define the network ID and the host ID. Because IP addresses are difficult to remember, they usually have an associated domain name that can be specified instead. See also <i>domain name</i>, <i>network mask</i>.</p>
ISP	<p>Internet Service Provider</p> <p>A company that provides Internet access to its customers, usually for a fee.</p>
LAN	<p>Local Area Network</p> <p>A network limited to a small geographic area, such as a home, office, or small building.</p>
LED	<p>Light Emitting Diode</p> <p>An electronic light-emitting device. The indicator lights on the front of the SL-1000 are LEDs.</p>
MAC address	<p>Media Access Control address</p> <p>The permanent hardware address of a device, assigned by its manufacturer. MAC addresses are expressed as six pairs of characters.</p>
mask	<p>See <i>network mask</i>.</p>
Multicast	<p>To send data to a group of network devices.</p>

Mbps	Abbreviation for Megabits per second, or one million bits per second. Network data rates are often expressed in Mbps.
Monitor	Also called " <i>Roving Analysis</i> ", allow you to attach a network analyzer to one port and use it to monitor the traffics of other ports on the switch.
network	A group of computers that are connected together, allowing them to communicate with each other and share resources, such as software, files, etc. A network can be small, such as a <i>LAN</i> , or very large, such as the <i>Internet</i> .
network mask	A network mask is a sequence of bits applied to an IP address to select the network ID while ignoring the host ID. Bits set to 1 mean "select this bit" while bits set to 0 mean "ignore this bit." For example, if the network mask 255.255.255.0 is applied to the IP address 100.10.50.1, the network ID is 100.10.50, and the host ID is 1. <i>See also binary, IP address, subnet, "IP Addresses Explained" section.</i>
NIC	Network Interface Card An adapter card that plugs into your computer and provides the physical interface to your network cabling, which for Ethernet NICs is typically an RJ-45 connector. <i>See Ethernet, RJ-45.</i>
packet	Data transmitted on a network consists of units called packets. Each packet contains a payload (the data), plus overhead information such as where it came from (source address) and where it should go (destination address).

ping	Packet Internet (or Inter-Network) Groper A program used to verify whether the host associated with an IP address is online. It can also be used to reveal the IP address for a given domain name.
port	A physical access point to a device such as a computer or router, through which data flows into and out of the device.
protocol	A set of rules governing the transmission of data. In order for a data transmission to work, both ends of the connection have to follow the rules of the protocol.
remote	In a physically separate location. For example, an employee away on travel who logs in to the company's intranet is a remote user.
RJ-45	Registered Jack Standard-45 The 8-pin plug used in transmitting data over phone lines. Ethernet cabling usually uses this type of connector.
RMON	Remote Monitoring Extensions to SNMP, provide comprehensive network monitoring capabilities.
routing	Forwarding data between your network and the Internet on the most efficient route, based on the data's destination IP address and current network conditions. A device that performs routing is called a router.
SNMP	Simple Network Management Protocol The TCP/IP protocol used for network management.

STP	Spanning Tree Protocol The bridge protocol to avoid packet looping in a complicate network.
subnet	A subnet is a portion of a network. The subnet is distinguished from the larger network by a <i>subnet mask</i> which selects some of the computers of the network and excludes all others. The subnet's computers remain physically connected to the rest of the parent network, but they are treated as though they were on a separate network. <i>See also network mask.</i>
subnet mask	A mask that defines a subnet. <i>See also network mask.</i>
TCP	<i>See TCP/IP.</i>
TCP/IP	Transmission Control Protocol/Internet Protocol The basic protocols used on the Internet. TCP is responsible for dividing data up into packets for delivery and reassembling them at the destination, while IP is responsible for delivering the packets from source to destination. When TCP and IP are bundled with higher-level applications such as HTTP, FTP, Telnet, etc., TCP/IP refers to this whole suite of protocols.
Telnet/SSH	An interactive, character-based program used to access a remote computer. While HTTP (the web protocol) and FTP only allow you to download files from a remote computer, Telnet / SSH allows you to log into and use a computer from a remote location.

TFTP	<p>Trivial File Transfer Protocol</p> <p>A protocol for file transfers, TFTP is easier to use than File Transfer Protocol (FTP) but not as capable or secure.</p>
Trunk	<p>Two or more ports are combined as one virtual port, also called as Link Aggregation.</p>
TTL	<p>Time To Live</p> <p>A field in an IP packet that limits the life span of that packet. Originally meant as a time duration, the TTL is usually represented instead as a maximum hop count; each router that receives a packet decrements this field by one. When the TTL reaches zero, the packet is discarded.</p>
twisted pair	<p>The ordinary copper telephone wiring long used by telephone companies. It contains one or more wire pairs twisted together to reduce inductance and noise. Each telephone line uses one pair. In homes, it is most often installed with two pairs. For Ethernet LANs, a higher grade called Category 3 (CAT 3) is used for 10BASE-T networks, and an even higher grade called Category 5 (CAT 5) is used for 100BASE-T networks. <i>See also 10BASE-T, 100BASE-T, Ethernet.</i></p>
upstream	<p>The direction of data transmission from the user to the Internet.</p>
VLAN	<p>Virtual Local Area Network</p>
WAN	<p>Wide Area Network</p> <p>Any network spread over a large geographical area, such as a country or continent. With respect to the SL-1000, WAN refers to the Internet.</p>

- Web browser** A software program that uses Hyper-Text Transfer Protocol (HTTP) to download information from (and upload to) web sites, and displays the information, which may consist of text, graphic images, audio, or video, to the user. Web browsers use Hyper-Text Transfer Protocol (HTTP). Popular web browsers include Netscape Navigator and Microsoft Internet Explorer. See also *HTTP, web site, WWW*.
- Web page** A web site file typically containing text, graphics and hyperlinks (cross-references) to the other pages on that web site, as well as to pages on other web sites. When a user accesses a web site, the first page that is displayed is called the *home page*. See also *hyperlink, web site*.
- Web site** A computer on the Internet that distributes information to (and gets information from) remote users through web browsers. A web site typically consists of web pages that contain text, graphics, and hyperlinks. See also *hyperlink, web page*.
- WWW** World Wide Web
Also called *(the) Web*. Collective term for all web sites anywhere in the world that can be accessed via the Internet

9 Index

- 100BASE-T, 136
- 10BASE-T, 136
- Administration page, 39
- Attach page, 77
- Binary numbers, 136
- Bits, 136
- Boot Rom Command Mode, 90
- Boot Rom Commmands, 91
- Bridge Commands, 96
- Bridge page, 47
- Broadcast, 137
- CLI Commands, 92
- Community Commands, 106
- Community Table page, 67
- Configuration Manager
 - troubleshooting, 135
- Console Interface, 88
- CoS Queue Mapping page, 65
- Default Port VLAN and CoS page,
 - 64
 - download, 137
- Dynamic Address Commands,
 - 102
- Dynamic Address page, 59
- Error Group page, 85
- Ethernet
 - defined, 137
- Filter Attach Commands, 117
- Filter Set, 75
- Filter Set Commands, 113
- Filtering rule, 137
- Filters Commands, 113, 117
- Filters pages, 74
- Firmware Upgrade page, 40
- FTP, 137
- Hardware connections, 22, 24
- Historical Status page, 86

Host, 137
troubleshooting, 134

Host ID, 123
Link Aggregation page, 50

Host Table Commands, 107, 109
Login and Logout, 92

Host Table page, 68
MAC addresses, 139

HTTP, 138
Management page, 35

ICMP, 138
Mask. See Network mask

IGMP, 138
Mbps, 140

IGMP Snooping, 138
, 99

IGMP Snooping page, 57
Mirroring page, 53

Internet, 138
Multicast Commands, 100

troubleshooting access to, 134
Network. See LAN

Intranet, 138
Network classes, 125

IP addresses, 139
Network ID, 123

explained, 123
Network mask, 140

IP Setup page, 37
Network mask, 126

ISP, 139
NIC, 140

LAN, 139
nslookup, 130

LAN IP Address Configuration,
Packet, 141

94
Password

LEDs, 139
default, 28, 31

- recovering, 135
- Physical Interface Commands, 95
- Physical Interface page, 42
- Ping, 128, 141
- Port, 141
- POST, 89
- Power adapter, 23
- Power On Self Test, 89
- Protocol, 141
- Quick Configuration
 - console logging in, 25
- Reboot page, 40
- Remote, 141
- RJ-45, 141
- Routing, 142
- RPS module, 23
- Save Configuration page, 87
- Set page, 74
- SNMP, 142
- SNMP Commands, 106
- SNMP pages, 67
- Spanning Tree Commands, 96
- Spanning Tree page, 47
- Static Address Commands, 102
- Static Address page, 60
- Static Multicast page, 56
- Statistics Chart pages, 84
- STP, 142
- Subnet, 142
- Subnet mask. See Network mask
- Subnet masks, 126
- System Commands, 92
- Tagged VLAN Commands, 103
- Tagged VLAN page, 61
- TCP/IP, 142
- Telnet, 143
- TFTP, 143
- Traffic Comparison page, 84
- Traffic Control Commands, 101
- Traffic Control page, 58
- Trap Setting Commands, 108

Trap Setting page, 69	WAN, 144
Troubleshooting, 128	Web browser, 144
Trunk, 143	Web function layout, 33
Trunk Commands, 97	Web Interface, 27
TTL, 143	Web page, 144
Twisted pair, 143	Web site, 144
Upstream, 144	Web top frame, 33
Username	World Wide Web, 145
default, 28, 31	